



EGLO

my light | my style



TREND & STYLE

COLLECTION

2022/23





## TREND & STYLE COLLECTION

Dear reader,

Vintage, the enduringly popular interior design style, has adorned the homes of our customers for several years now and continues to exhibit stunning versatility, reflecting the charm of past decades. We have taken inspiration from this style in our luminaire designs, allowing our customers to add a little extra character to their homes with some of our lighting fixtures.

Interior design trends are as rich and diverse as life itself, and new trends are discovered and reinterpreted every year. New trends and styles are constantly being created by combining and recombining different materials and designs. Our own catalogue seeks to showcase this near-limitless range of ideas and options.

Liebe Leserin, lieber Leser,

der bis heute so beliebte Einrichtungsstil Vintage verschönert das Heim unserer Kunden schon seit mehreren Jahren und versprüht durch seine Vielfältigkeit den Charme aus verschiedenen Jahrzehnten. Von diesem Flair haben wir uns bei unseren Leuchten Designs gerne inspirieren lassen und unseren Kunden so ermöglicht, mit ihrer Beleuchtung Persönlichkeit in die eigenen 4-Wände zu bringen.

Einrichtungstrends sind so facettenreich wie das Leben selbst und werden Jahr für Jahr neu entdeckt und -interpretiert. Durch die Kombinationen von unterschiedlichen Materialien und Designs werden immer neue Trends und Stile geschaffen. Diese nahezu grenzenlosen Ideen und Möglichkeiten haben uns dazu veranlasst, den Trend-Welten mit unserem Katalog die passende Bühne zu bieten.

Chère lectrice, cher lecteur,

Très en vogue, le style vintage embellit l'intérieur de nos clients depuis de nombreuses années déjà et, grâce à sa grande diversité, diffuse le charme de différentes décennies. Nous avons souhaité nous inspirer de cet esprit pour le design de nos luminaires et ainsi permettre à nos clients de refléter leur propre personnalité dans leur foyer à l'aide d'éléments d'éclairage bien choisis.

Les tendances en matière d'aménagement sont aussi diversifiées que la vie elle-même, et chaque année apporte son lot de nouvelles découvertes et de réinterprétations. L'association de différents matériaux et designs donne constamment naissance à de nouvelles tendances et à de nouveaux styles. Cette abondance d'idées et de possibilités nous a incités à mettre en avant les différents univers de tendances dans notre catalogue.

# EDITORIAL

Our Trend & Style collection features the latest trends for the 2022/23 season.

Our luminaire portfolio has been expanded to include exciting compositions made from natural materials, metal and glass. Metal wrapped in hemp yarn and bamboo frames covered in fabric are just two of the highlights of our new luminaire designs.

In der Trend & Style Kollektion erwarten Sie die aktuellen Trend-Welten der Saison 2022/23.

Unser Leuchten Portfolio wurde um spannende Kompositionen aus Naturmaterialien, Metall und Glas ergänzt. Mit Hanfgarn umwickeltes Metall und mit Textil umspannte Bambusrahmen sind die Highlights unserer neuen Leuchten-Designs.

Dans la collection Trend & Style, vous trouverez toutes les tendances actuelles de la saison 2022/23.

Notre gamme de luminaires est complétée de splendides compositions mêlant matériaux naturels, métal et verre. Le métal enveloppé dans du fil de chanvre et les cadres en bambou associés à des matières textiles sont les éléments phares de nos nouveaux designs de luminaires.

INDUSTRIAL

P.04



LOFT

P.76



VINTAGE

P.194



NATURE

P.216

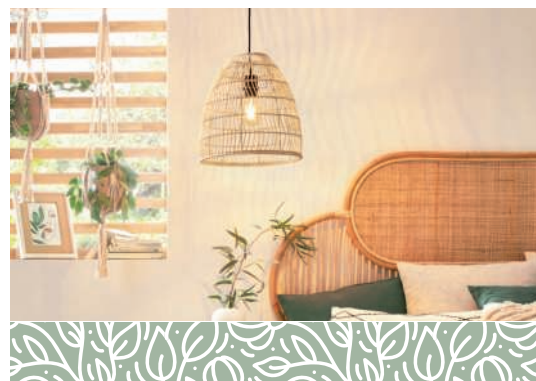

COTTAGE CHIC

P.240



ETHNO ELEGANCE

P.254



SOCKETS

P.266

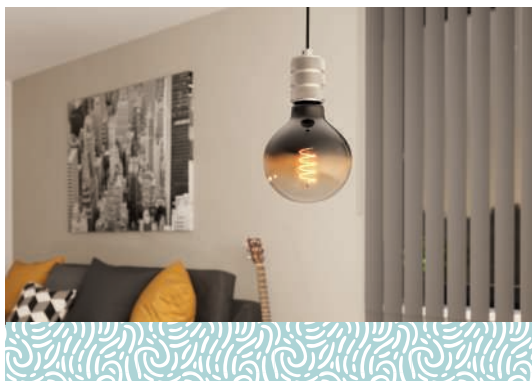

ILLUMINANTS

P.272









































# INDUSTRIAL

Soft lines, playful curves and comfort? Certainly not. The industrial range is dominated by hard and functional elements. Raw metal parts are turned into luminaires and spread the rough style of factory halls. The Industrial Look celebrates the aesthetic of things imperfect.

Weiche Linien, verspielte Rundungen und Gemütlichkeit? Mitnichten. Im Industrial-Sortiment dominieren harte und funktionelle Elemente. Rohe Metallteile werden zu Leuchten verarbeitet und verbreiten den groben Stil von Fabrikhallen. Der Industrial Look zelebriert die Ästhetik des Imperfekten.

Des lignes tendres, des arrondis enjoués et de la convivialité ? En aucun cas. Des éléments durs et fonctionnels dominent la gamme industrielle. Des pièces métalliques brutes sont usinées pour devenir des luminaires et diffusent le style franc d'usines. Le look industriel symbolise l'esthétique de l'imperfection.



<b>MILLIGAN</b> p. 6-9	<b>JUBILY</b> p. 10-11	<b>DELOW</b> p. 12-13	<b>MANBY</b> p. 14-15	<b>REDCLIFFE</b> p. 16-17	<b>CATTERICK</b> p. 18-19	<b>IKESTON</b> p. 20-21	<b>SPEKE</b> p. 22
							
<b>SEDBERGH</b> p. 23	<b>BRICKFIELD</b> p. 24	<b>FORESTBURG</b> p. 25	<b>HILCOTT</b> p. 26-27	<b>TURROCK</b> p. 28-29	<b>TAKELEY</b> p. 30	<b>BARNSTAPLE 1</b> p. 32-33	<b>SHIREBROOK</b> p. 33
							
<b>BARNSTAPLE</b> p. 34-37	<b>LUBENHAM 1</b> p. 38	<b>LUBENHAM</b> p. 38-39	<b>WINKWORTH 1</b> p. 40	<b>EBURY</b> p. 41	<b>TRURO 1</b> p. 42	<b>TRURO 2</b> p. 42, 44	<b>ROCKINGHAM</b> p. 42
							
<b>GRANTHAM 1</b> p. 43	<b>AUCKLAND</b> p. 44	<b>TRURO</b> p. 44	<b>PRIDDY 1</b> p. 45	<b>PRIDDY</b> p. 46-48	<b>TREBURLEY</b> p. 50	<b>COVALEDA 1</b> p. 50	<b>COVALEDA</b> p. 53
							
<b>EMBLETON</b> p. 54	<b>MARDYKE</b> p. 56-57	<b>LONGINO</b> p. 58	<b>CHARTERHOUSE</b> p. 59	<b>ELSWICK</b> p. 60	<b>FEMBARD</b> p. 60	<b>WILMCOTE</b> p. 61	<b>EXMOOR</b> p. 61
							
<b>OLDBURY</b> p. 62	<b>PORT SETON</b> p. 63	<b>TOWNSHEND 4</b> p. 63-65	<b>PRESTWICK 2</b> p. 66-67	<b>PRESTWICK 1</b> p. 67	<b>GATEBECK</b> p. 68-69	<b>LAYHAM</b> p. 70-71	<b>HARBOROUGH</b> p. 72
							
<b>EVESHAM</b> p. 72-73	<b>KILNSDALE</b> p. 74						
							



This product is available in different colors and shapes./ Dieser Artikel ist in unterschiedlichen Farben und Formen verfügbar.  
Cet article est disponible en différentes couleurs et formes.



### 43625 MILLIGAN

pendant light; steel, black, white  
 Hängeleuchte; Stahl, schwarz, weiss  
 luminaire en suspension; acier, noir, blanc

H 1100, Ø 200



9 002759 436254



### 43626 MILLIGAN

pendant light; steel, black, white  
 Hängeleuchte; Stahl, schwarz, weiss  
 luminaire en suspension; acier, noir, blanc

L 1030, B 200, H 1100



9 002759 436261

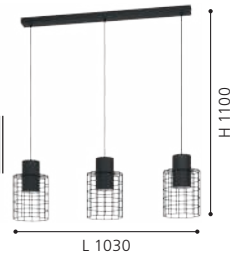

### 43628 MILLIGAN

pendant light; steel, black, white  
 Hängeleuchte; Stahl, schwarz, weiss  
 luminaire en suspension; acier, noir, blanc

H 1100, Ø 480



9 002759 436285

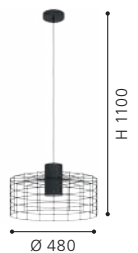





43627

### 43627 MILLIGAN

pendant light; steel, black, white  
Hängeleuchte; Stahl, schwarz, weiss  
luminaire en suspension; acier, noir, blanc

H 1100, Ø 380



E27



1x 40W



9 002759 436278



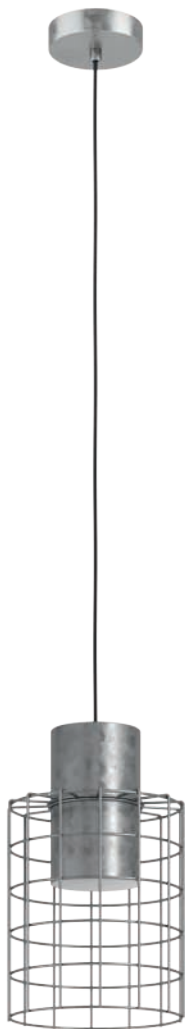

43647



43648

### 43647 MILLIGAN

pendant light; steel, zinc-plated, white  
Hängeleuchte; Stahl, verzinkt, weiss  
luminaire en suspension; acier, galvanisé, blanc

H 1100, Ø 200



E27



1x 40W



9 002759 436476

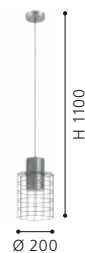

### 43648 MILLIGAN

pendant light; steel, zinc-plated, white  
Hängeleuchte; Stahl, verzinkt, weiss  
luminaire en suspension; acier, galvanisé, blanc

L 930, B 200, H 1100



E27



3x 40W



9 002759 436483

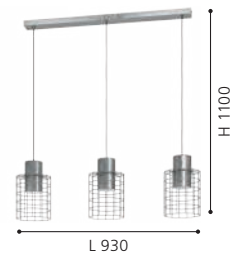

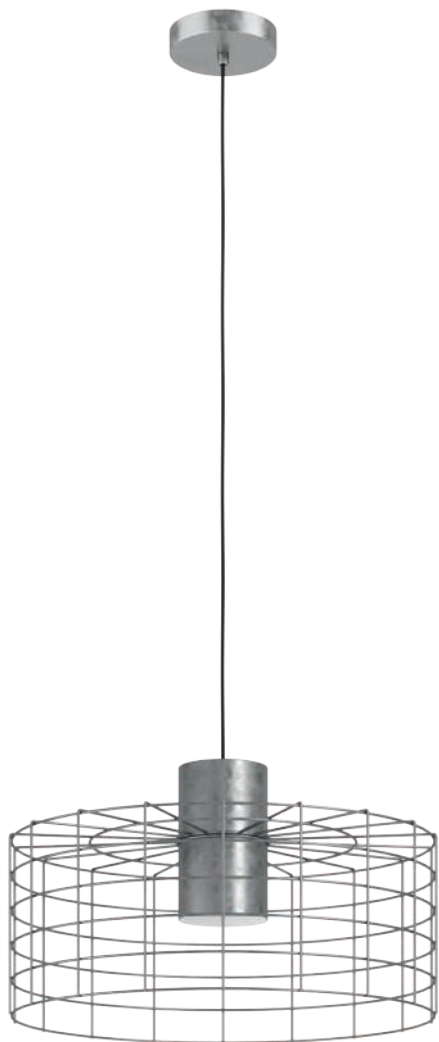

43651



43649

### 43651 MILLIGAN

pendant light; steel, zinc-plated, white  
 Hängeleuchte; Stahl, verzinkt, weiss  
 luminaire en suspension; acier, galvanisé, blanc

H 1100, Ø 480



E27



1x 40W



9 002759 436513

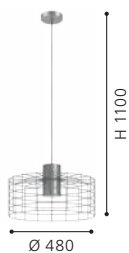

### 43649 MILLIGAN

pendant light; steel, zinc-plated, white  
 Hängeleuchte; Stahl, verzinkt, weiss  
 luminaire en suspension; acier, galvanisé, blanc

H 1100, Ø 380



E27



1x 40W



9 002759 436490

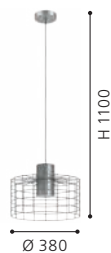

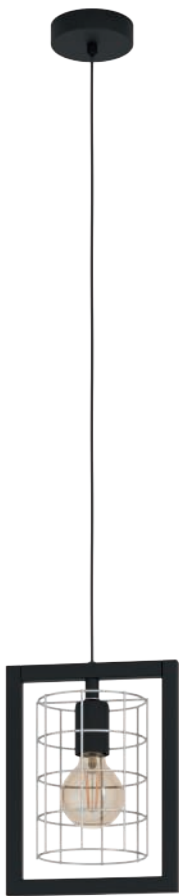

43662

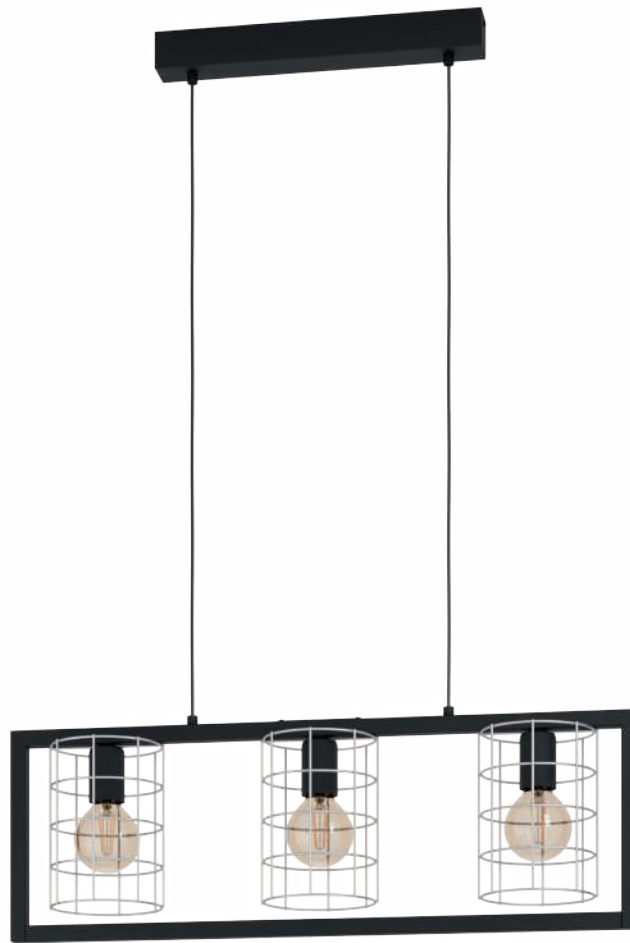

43663



43664

### 43662 JUBILY

pendant light; steel, black / steel, zinc-plated  
 Hängeleuchte; Stahl, schwarz / Stahl, verzinkt  
 luminaire en suspension; acier, noir / acier, galvanisé

L 220, B 145, H 1100



E27 1x 40W



9 002759 436629



### 43663 JUBILY

pendant light; steel, black / steel, zinc-plated  
 Hängeleuchte; Stahl, schwarz / Stahl, verzinkt  
 luminaire en suspension; acier, noir / acier, galvanisé

L 770, B 145, H 1100



E27 3x 40W



9 002759 436636

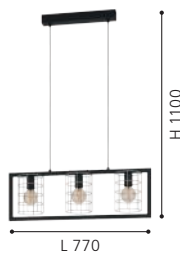

### 43664 JUBILY

wall light; steel, black / steel, zinc-plated  
 Wandleuchte; Stahl, schwarz / Stahl, verzinkt  
 applique; acier, noir / acier, galvanisé

L 220, H 290, A 195



E27 1x 40W



9 002759 436643





43661



43665

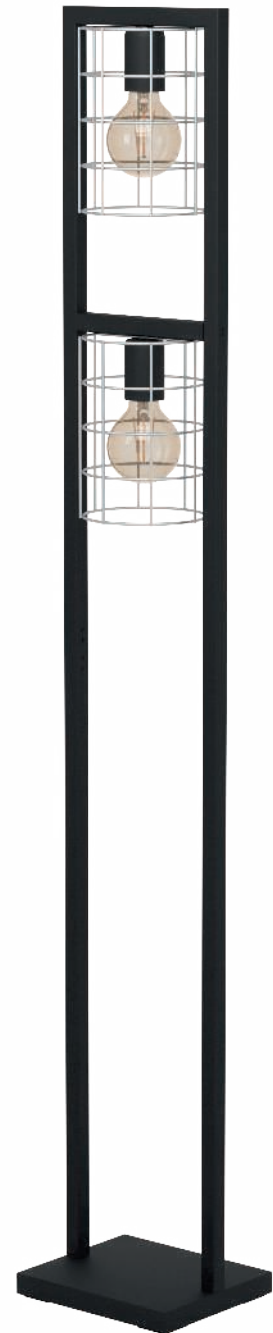

43666

### 43661 JUBILY

ceiling light; steel, black / steel, zinc-plated  
Deckenleuchte; Stahl, schwarz / Stahl, verzinkt  
plafonnier; acier, noir / acier, galvanisé

L 770, B 190, H 255



E27 3x 40W



9 002759 436612



### 43665 JUBILY

table light; steel, black / steel, zinc-plated  
Tischleuchte; Stahl, schwarz / Stahl, verzinkt  
luminaire de table; acier, noir / acier, galvanisé

L 220, B 145, H 535, Base: B 220, T 150



E27 1x 40W



9 002759 436650



### 43666 JUBILY

floor light; steel, black / steel, zinc-plated  
Stehleuchte; Stahl, schwarz / Stahl, verzinkt  
lampadaire; acier, noir / acier, galvanisé

L 220, B 145, H 1455, Base: B 220, T 190



E27 2x 40W



9 002759 436667

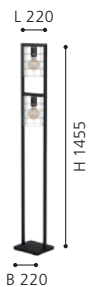



43605



43603



43604

### 43605 DELLOW

pendant light; steel, black / steel, black, brass  
 Hängeleuchte; Stahl, schwarz / Stahl, schwarz, messing  
 luminaire en suspension; acier, noir / acier, noir, laiton

L 880, B 180, H 1100



E27 3x 40W



9 002759 436056



### 43604 DELLOW

pendant light; steel, black / steel, black, brass  
 Hängeleuchte; Stahl, schwarz / Stahl, schwarz, messing  
 luminaire en suspension; acier, noir / acier, noir, laiton

H 1100, Ø 450



E27 1x 40W



9 002759 436049



### 43603 DELLOW

ceiling light; steel, black / steel, black, brass  
 Deckenleuchte; Stahl, schwarz / Stahl, schwarz, messing  
 plafonnier; acier, noir / acier, noir, laiton

H 270, Ø 450



E27 1x 40W



9 002759 436032





43533



43532



43531

### 43533 DELLOW

spot; steel, black / steel, black, brass  
 Spot; Stahl, schwarz / Stahl, schwarz, messing  
 spot; acier, noir / acier, noir, laiton

L 830, B 180, H 210



E27



3x 40W



9 002759 435332



L 830

H 210

### 43532 DELLOW

spot; steel, black / steel, black, brass  
 Spot; Stahl, schwarz / Stahl, schwarz, messing  
 spot; acier, noir / acier, noir, laiton

L 475, B 180, H 210



E27



2x 40W



9 002759 435325



L 475

H 210

### 43531 DELLOW

spot; steel, black / steel, black, brass  
 Spot; Stahl, schwarz / Stahl, schwarz, messing  
 spot; acier, noir / acier, noir, laiton

L 180, B 110, H 200



E27



1x 40W



9 002759 435318

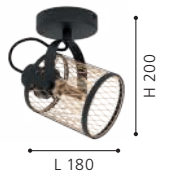

L 180

H 200



43796

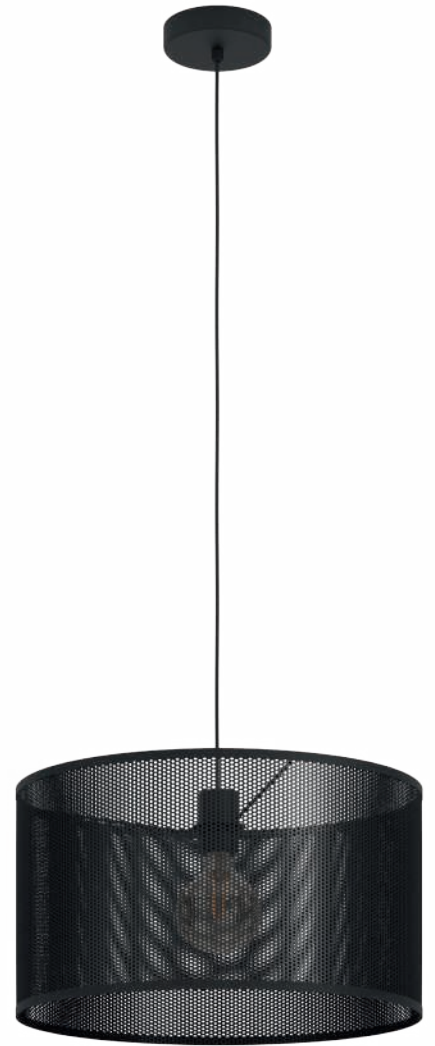

43795

**43796 MANBY**

pendant light; steel, black  
 Hängeleuchte; Stahl, schwarz  
 luminaire en suspension; acier, noir

L 900, B 200, H 1100



E27



3x 40W



9 002759 437961



**43795 MANBY**

pendant light; steel, black  
 Hängeleuchte; Stahl, schwarz  
 luminaire en suspension; acier, noir

H 1100, Ø 450



E27



1x 40W



9 002759 437954

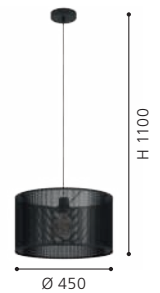





43794



43797

### 43794 MANBY

ceiling light; steel, black  
Deckenleuchte; Stahl, schwarz  
plafonnier; acier, noir

H 280, Ø 450



E27



1x 40W



9 002759 437947

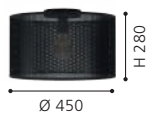

### 43797 MANBY

table light; steel, black  
Tischleuchte; Stahl, schwarz  
luminaire de table; acier, noir

H 485, Ø 240, Base: Ø 230



E27



1x 40W



9 002759 437978





#### DETAIL 43534

To replace the bulbs, the lamp can be taken apart in the middle.  
Zum Tausch der Leuchtmittel können die beiden Hälften der Leuchte in der Mitte auseinander genommen werden.  
Pour remplacer les ampoules, la luminaire peut être démontée au milieu.



#### 43534 REDCLIFFE

pendant light; steel, black  
Hängeleuchte; Stahl, schwarz  
luminaire en suspension; acier, noir

L 1080, B 125, H 1100



E27



4x 40W



9 002759 435349

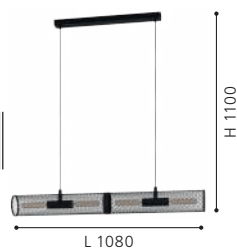

#### 43535 REDCLIFFE

wall / ceiling light; steel, black  
Wand- / Deckenleuchte; Stahl, schwarz  
applique / plafonnier; acier, noir

L 540, B 120, H 145



E27



2x 40W



9 002759 435356

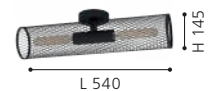



43538



43536



43537

### 43538 REDCLIFFE

wall light; steel, black  
Wandleuchte; Stahl, schwarz  
applique; acier, noir

L 120, H 280, A 145



E27



1x 40W



9 002759 435387



### 43536 REDCLIFFE

table light; steel, black  
Tischleuchte; Stahl, schwarz  
luminaire de table; acier, noir

H 380, Ø 120, Base: Ø 120



E27



1x 40W



9 002759 435363



### 43537 REDCLIFFE

floor light; steel, black  
Stehleuchte; Stahl, schwarz  
lampadaire; acier, noir

H 1355, Ø 120, Base: Ø 250



E27



4x 40W



9 002759 435370



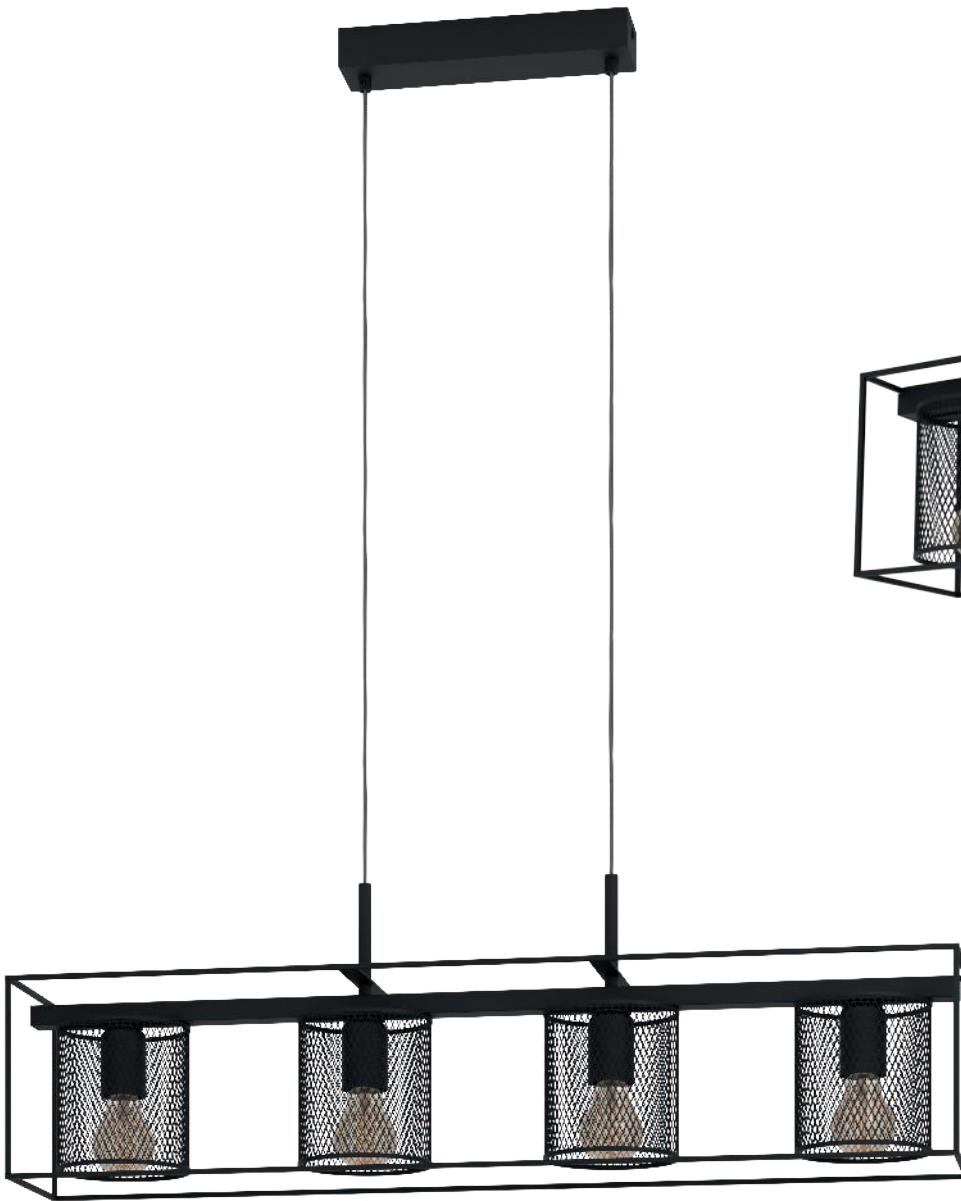

43773



43772

### 43773 CATTERICK

pendant light; steel, black  
Hängeleuchte; Stahl, schwarz  
luminaire en suspension; acier, noir

L 910, B 165, H 1100



E27 4x 40W



9 002759 437732

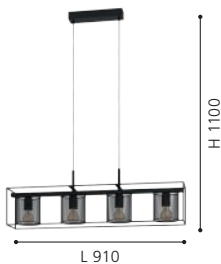

### 43772 CATTERICK

ceiling light; steel, black  
Deckenleuchte; Stahl, schwarz  
plafonnier; acier, noir

L 350, B 165, H 190



E27 2x 40W



9 002759 437725



### 43771 CATTERICK

ceiling light; steel, black  
Deckenleuchte; Stahl, schwarz  
plafonnier; acier, noir

L 165, B 165, H 190



E27 1x 40W



9 002759 437718





43771



43774

### 43774 CATTERICK

table light; steel, black  
Tischleuchte; Stahl, schwarz  
luminaire de table; acier, noir

L 165, B 165, H 190



E27



1x 40W



9 002759 437749

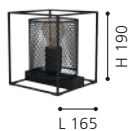

DESIGN  
HIGHLIGHT  
DETAIL





43728

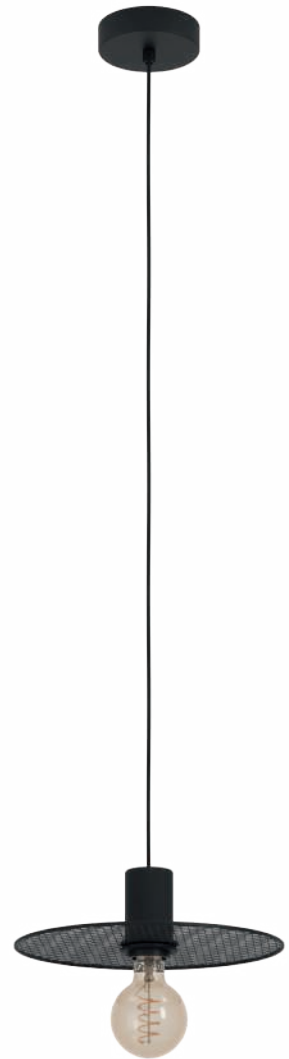

43731

### 43728 IKESTON

ceiling light; steel, black  
Deckenleuchte; Stahl, schwarz  
plafonnier; acier, noir

H 130, Ø 530



E27



3x 40W



9 002759 437282



### 43731 IKESTON

pendant light; steel, black  
Hängeleuchte; Stahl, schwarz  
luminaire en suspension; acier, noir

H 1100, Ø 280



E27



1x 40W



9 002759 437312

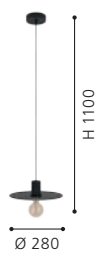



43729



43732

### 43732 IKESTON

pendant light; steel, black  
 Hängeleuchte; Stahl, schwarz  
 luminaire en suspension; acier, noir

L 980, B 280, H 1100



E27



4x 40W



9 002759 437329

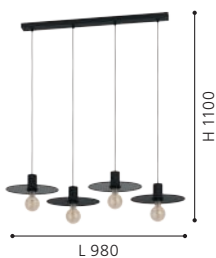

### 43729 IKESTON

ceiling light; steel, black  
 Deckenleuchte; Stahl, schwarz  
 plafonnier; acier, noir

L 950, B 330, H 120



E27



4x 40W



9 002759 437299





43722



43721

### 43722 SPEKE

ceiling light; steel, black  
Deckenleuchte; Stahl, schwarz  
plafonnier; acier, noir

L 1560, B 310, H 105



E27



11x 40W



9 002759 437220

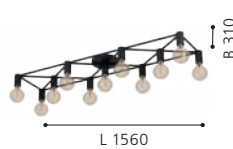

L 1560

### 43721 SPEKE

ceiling light; steel, black  
Deckenleuchte; Stahl, schwarz  
plafonnier; acier, noir

L 415, B 310, H 105



E27



5x 40W



9 002759 437213

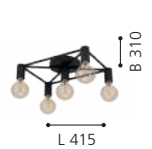

L 415



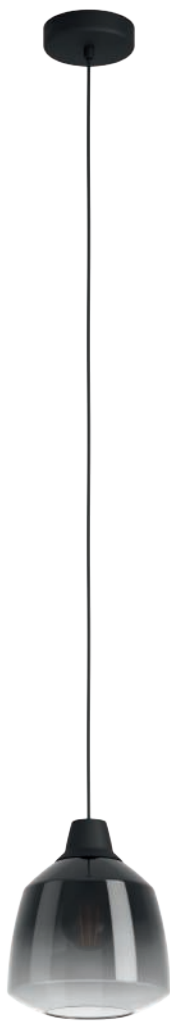

43821



43822

### 43821 SEDBERGH

pendant light; steel, black / glass, black-grey-transparent  
Hängeleuchte; Stahl, schwarz / Glas, schwarz-grau-transparent  
luminaire en suspension; acier, noir / verre, noir-gris-transparent

H 1100, Ø 200



E27



1x 40W



9 002759 438210



### 43822 SEDBERGH

pendant light; steel, black / glass, black-grey-transparent  
Hängeleuchte; Stahl, schwarz / Glas, schwarz-grau-transparent  
luminaire en suspension; acier, noir / verre, noir-gris-transparent

L 900, B 200, H 1100



E27



3x 40W



9 002759 438227



DESIGN  
HIGHLIGHT  
DETAIL

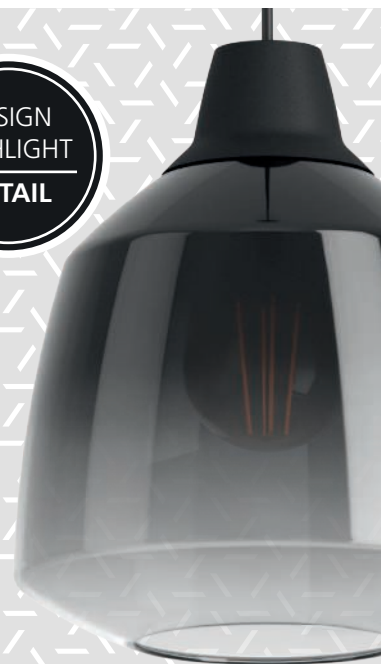

## DETAIL 43395

The mounting bracket of the light fitting can be individually adjusted.  
Die Aufhängung der Leuchtenköpfe kann individuell eingestellt werden.  
La suspension des têtes de luminaire est réglable.

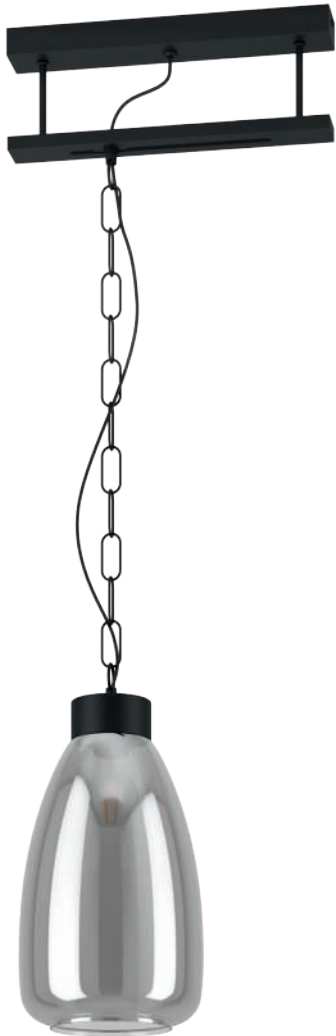

43394



43395

### 43394 BRICKFIELD

pendant light; steel, black / glass vaporized, black-transparent  
Hängeleuchte; Stahl, schwarz / Glas bedampft, schwarz-transparent  
luminaire en suspension; acier, noir / verre vaporisé, noir transparent

L 350, B 200, H 1085



E27



1x 40W



9 002759 433949



### 43395 BRICKFIELD

pendant light; steel, black / glass vaporized, black-transparent  
Hängeleuchte; Stahl, schwarz / Glas bedampft, schwarz-transparent  
luminaire en suspension; acier, noir / verre vaporisé, noir transparent

L 770, B 200, H 1085



E27



2x 40W



9 002759 433956

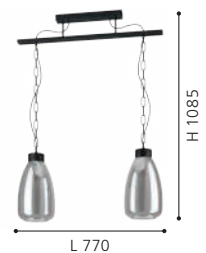



43308



43309

### 43308 FORESTBURG

ceiling light; steel, black / glass vaporized, black-transparent  
 Deckenleuchte; Stahl, schwarz / Glas bedampft, schwarz-transparent  
 plafonnier; acier, noir / verre vaporisé, noir transparent

H 275, Ø 665



E27



3x 40W



9 002759 433086



### 43309 FORESTBURG

wall light; steel, black / glass vaporized, black-transparent  
 Wandleuchte; Stahl, schwarz / Glas bedampft, schwarz-transparent  
 applique; acier, noir / verre vaporisé, noir transparent

L 115, H 290, A 310



E27



1x 40W



9 002759 433093



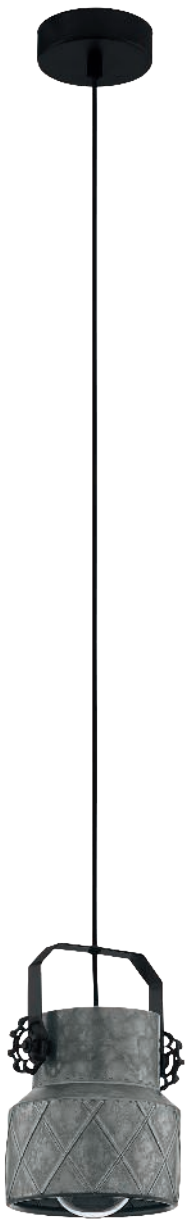

39854



39855

### 39854 HILCOTT

pendant light; steel, black / steel, zinc-plated  
 Hängeleuchte; Stahl, schwarz / Stahl, verzinkt  
 luminaire en suspension; acier, noir / acier, galvanisé

H 1100, Ø 145



E27 1x 40W



9 002759 398545



### 39855 HILCOTT

pendant light; steel, black / steel, zinc-plated  
 Hängeleuchte; Stahl, schwarz / Stahl, verzinkt  
 luminaire en suspension; acier, noir / acier, galvanisé

L 1160, B 145, H 1100



E27 5x 40W



9 002759 398552

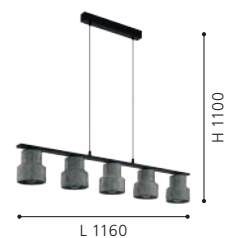



39868



39857



39856

### 39868 HILCOTT

wall light; steel, black / steel, zinc-plated  
Wandleuchte; Stahl, schwarz / Stahl, verzinkt  
applique; acier, noir / acier, galvanisé

L 160, H 200, A 245



E27



1x 40W



9 002759 398682



### 39857 HILCOTT

table light; steel, black / steel, zinc-plated  
Tischleuchte; Stahl, schwarz / Stahl, verzinkt  
luminaire de table; acier, noir / acier, galvanisé

L 265, B 160, H 480, Base: Ø 170



E27



1x 40W



9 002759 398576



### 39856 HILCOTT

pendant light; steel, black / steel, zinc-plated  
Hängeleuchte; Stahl, schwarz / Stahl, verzinkt  
luminaire en suspension; acier, noir / acier, galvanisé

H 1500, Ø 675



E27



5x 40W



9 002759 398569

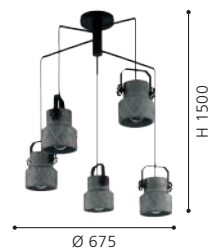



43444



43445



43446

### 43444 TURROCK

wall / ceiling light; steel, grey-patina, black  
Wand- / Deckenleuchte; Stahl, grau-patina, schwarz  
applique / plafonnier; acier, gris patiné, noir

L 160, B 160, H 300



E27



1x 28W



9 002759 434441



L 160

H 300

### 43445 TURROCK

wall / ceiling light; steel, grey-patina, black  
Wand- / Deckenleuchte; Stahl, grau-patina, schwarz  
applique / plafonnier; acier, gris patiné, noir

L 475, B 160, H 300



E27



2x 28W



9 002759 434458



L 475

H 300

### 43446 TURROCK

wall / ceiling light; steel, grey-patina, black  
Wand- / Deckenleuchte; Stahl, grau-patina, schwarz  
applique / plafonnier; acier, gris patiné, noir

L 750, B 160, H 300



E27



3x 28W



9 002759 434465



L 750

H 300



43447

### 43447 TURROCK

pendant light; steel, grey-patina, black  
Hängeleuchte; Stahl, grau-patina, schwarz  
luminaire en suspension; acier, gris patiné, noir

L 880, B 180, H 1100



E27



3x 28W



9 002759 434472



DESIGN  
HIGHLIGHT  
DETAIL



## DETAIL TAKELEY

The arms of the luminaires are individually adjustable.  
Die Arme der Leuchten sind individuell einstellbar.  
Les bras des luminaires sont réglables individuellement.



43562

### 43562 TAKELEY

ceiling light; steel, black  
Deckenleuchte; Stahl, schwarz  
plafonnier; acier, noir

B 1980, H 1325



E27



2x 28W



9 002759 435622

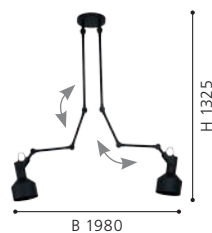

### 43561 TAKELEY

ceiling light; steel, black  
Deckenleuchte; Stahl, schwarz  
plafonnier; acier, noir

H 1325, Ø 150



E27



1x 28W



9 002759 435615

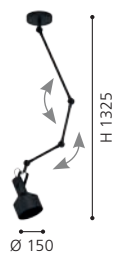





43561





43431



43432



43433

### 43431 BARNSTAPLE 1

spot; wood, steel, black / steel, black  
Spot; Holz, Stahl, schwarz / Stahl, schwarz  
spot; bois, acier, noir / acier, noir

L 160, B 160



E27 1x 28W



9 002759 434311

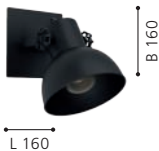

L 160

B 160

### 43432 BARNSTAPLE 1

spot; wood, steel, black / steel, black  
Spot; Holz, Stahl, schwarz / Stahl, schwarz  
spot; bois, acier, noir / acier, noir

L 475, B 90



E27 2x 40W



9 002759 434328



L 475

B 90

### 43433 BARNSTAPLE 1

spot; wood, steel, black / steel, black  
Spot; Holz, Stahl, schwarz / Stahl, schwarz  
spot; bois, acier, noir / acier, noir

L 750, B 90



E27 3x 40W



9 002759 434335



L 750

B 90



43434



43726



### 43434 BARNSTAPLE 1

spot; wood, steel, black / steel, black  
Spot; Holz, Stahl, schwarz / Stahl, schwarz  
spot; bois, acier, noir / acier, noir

L 450, B 450



E27



4x 40W



9 002759 434342



### 43726 SHIREBROOK

pendant light; steel, wood, black  
Hängeleuchte; Stahl, Holz, schwarz  
luminaire en suspension; acier, bois, noir

L 1000, B 250, H 1100



E27



4x 40W



9 002759 437268

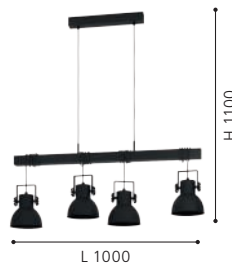



49649

49653

49652

**49649 BARNSTAPLE**

spot; wood, steel, brown-patina, black / steel, used look Zinc Spot; Holz, Stahl, braun-patina, schwarz / Stahl, used look Zink spot; bois, acier, marron patiné, noir / acier, look zinc usé

L 475, B 90



E27 2x 40W



9 002759 496494



**49652 BARNSTAPLE**

spot; wood, steel, brown-patina, black / steel, used look Zinc Spot; Holz, Stahl, braun-patina, schwarz / Stahl, used look Zink spot; bois, acier, marron patiné, noir / acier, look zinc usé

L 750, B 90



E27 3x 40W



9 002759 496524



**49653 BARNSTAPLE**

spot; wood, steel, brown-patina, black / steel, used look Zinc Spot; Holz, Stahl, braun-patina, schwarz / Stahl, used look Zink spot; bois, acier, marron patiné, noir / acier, look zinc usé

L 450, B 450



E27 4x 40W



9 002759 496531





49648

### 49648 BARNSTAPLE

spot; wood, steel, brown-patina, black / steel, used look Zinc  
Spot; Holz, Stahl, braun-patina, schwarz / Stahl, used look Zinc  
spot; bois, acier, marron patiné, noir / acier, look zinc usé

L 160, B 160



E27



1x 40W



9 002759 496487



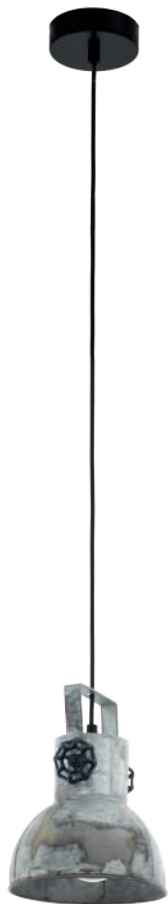

49619



49647



49722

### 49619 BARNSTAPLE

pendant light; steel, black / steel, used look Zinc  
 Hängeleuchte; Stahl, schwarz / Stahl, used look Zinc  
 luminaire en suspension; acier, noir / acier, look zinc usé

H 1100, Ø 175



E27 1x 40W



9 002759 496197



### 49647 BARNSTAPLE

pendant light; wood, steel, brown-patina, black / steel, used look Zinc  
 Hängeleuchte; Holz, Stahl, braun-patina, schwarz / Stahl, used look Zinc  
 luminaire en suspension; bois, acier, marron patiné, noir / acier, look zinc usé  
 H 1500, Ø 270



E27 3x 40W



9 002759 496470



### 49722 BARNSTAPLE

floor light; wood, steel, brown-patina, black / steel, used look Zinc  
 Stehleuchte; Holz, Stahl, braun-patina, schwarz / Stahl, used look Zinc  
 lampadaire; bois, acier, marron patiné, noir / acier, look zinc usé

H 1580, Base: Ø 270



E27 2x 40W



9 002759 497224

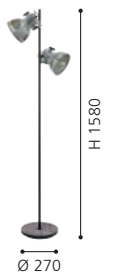



49718

**49718 BARNSTAPLE**

table light; wood, steel, brown-patina, black / steel, used look Zinc

Tischleuchte; Holz, Stahl, braun-patina, schwarz / Stahl, used look Zink

luminaire de table; bois, acier, marron patiné, noir / acier, look zinc usé

B 175, H 400, Base: Ø 180



E27



1x 40W



9 002759 497187



DESIGN  
HIGHLIGHT  
DETAIL





43168



43164



43162

### 43168 LUBENHAM 1

pendant light; steel, nickel-antique, creme  
 Hängeleuchte; Stahl, nickel-antik, creme  
 luminaire en suspension; acier, nickel antique, crème

L 900, B 200, H 1100



E27 3x 28W



9 002759 431686

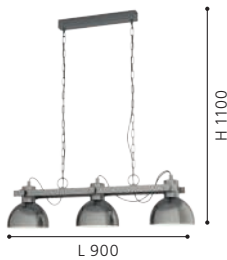

### 43162 LUBENHAM

pendant light; steel, wood, black, brown  
 Hängeleuchte; Stahl, Holz, schwarz, braun  
 luminaire en suspension; acier, bois, noir, marron

H 1100, Ø 300



E27 1x 28W



9 002759 431624

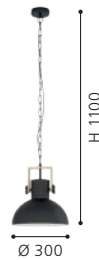

### 43164 LUBENHAM

wall light; steel, wood, black, brown  
 Wandleuchte; Stahl, Holz, schwarz, braun  
 applique; acier, bois, noir, marron

L 175, H 205, A 210



E27 1x 28W



9 002759 431648







### 43165 LUBENHAM

table light; steel, wood, black, brown  
Tischleuchte; Stahl, Holz, schwarz, braun  
luminaire de table; acier, bois, noir, marron

H 570, Base: Ø 180

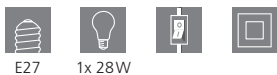

E27 1x 28W



9 002759 431655



### 43166 LUBENHAM

floor light; steel, wood, black, brown  
Stehleuchte; Stahl, Holz, schwarz, braun  
lampadaire; acier, bois, noir, marron

L 475, B 300, H 1600, Base: Ø 300



E27 1x 28W



9 002759 431662

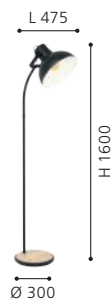

### 43163 LUBENHAM

pendant light; steel, wood, black, brown  
Hängeleuchte; Stahl, Holz, schwarz, braun  
luminaire en suspension; acier, bois, noir, marron

L 900, B 200, H 1100



E27 3x 28W



9 002759 431631





43435



43436



#### DETAIL WINKWORTH 1

The distance between light fitting and ceiling can be individually adjusted using the additional weight.

Der Abstand der Leuchte zur Decke ist durch das zusätzliche Gewicht individuell verstellbar.

L'espace séparant les têtes de luminaire du plafond peut être réglé grâce au poids supplémentaire.

#### 43435 WINKWORTH 1

pendant light; steel, black  
Hängeleuchte; Stahl, schwarz  
luminaire en suspension; acier, noir

H 910 - 1900, Ø 380



E27 1x 40W



9 002759 434359

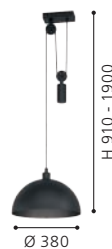

#### 43436 WINKWORTH 1

pendant light; steel, black  
Hängeleuchte; Stahl, schwarz  
luminaire en suspension; acier, noir

L 1180, B 380, H 910 - 1900



E27 2x 40W



9 002759 434366





43621



43622

### 43621 Ebury

pendant light; steel, black, white  
Hängeleuchte; Stahl, schwarz, weiss  
luminaire en suspension; acier, noir, blanc

H 1100, Ø 380



E27



1x 60W



9 002759 436216



### 43622 Ebury

pendant light; steel, grey, white  
Hängeleuchte; Stahl, grau, weiss  
luminaire en suspension; acier, gris, blanc

H 1100, Ø 380



E27



1x 60W



9 002759 436223



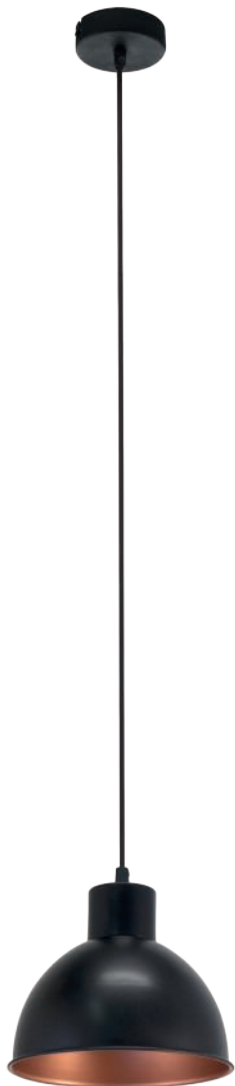

49238

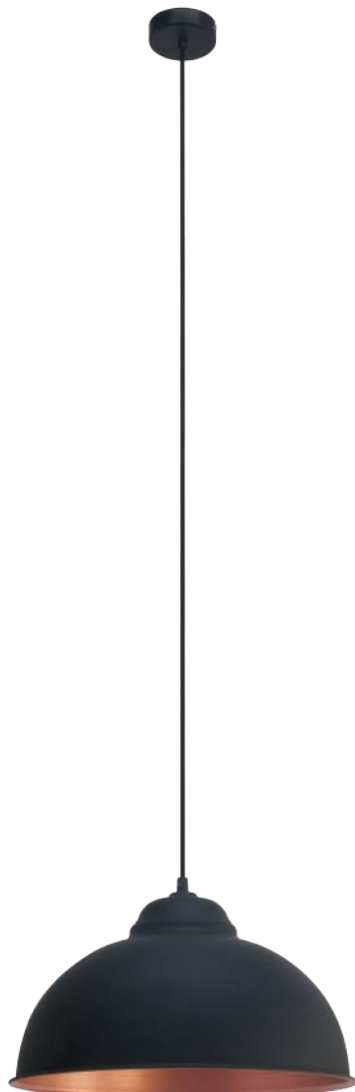

49247



43299

### 49238 TRURO 1

pendant light; steel, black, copper  
Hängeleuchte; Stahl, schwarz, kupfer  
luminaire en suspension; acier, noir, cuivre

H 1100, Ø 210



E27 1x 60W



9 002759 492380



### 49247 TRURO 2

pendant light; steel, black, copper  
Hängeleuchte; Stahl, schwarz, kupfer  
luminaire en suspension; acier, noir, cuivre

H 1100, Ø 370



E27 1x 60W



9 002759 492472



### 43299 ROCKINGHAM

pendant light; steel, black, brown  
Hängeleuchte; Stahl, schwarz, braun  
luminaire en suspension; acier, noir, marron

H 1500, Ø 530



E27 1x 40W



9 002759 432997





49819

### 49819 GRANTHAM 1

pendant light; steel, antique-brown, beige

Hängeleuchte; Stahl, antik-braun, beige

luminaire en suspension; acier, marron antique, beige

H 1100, Ø 370



E27



1x 60W



9 002759 498191



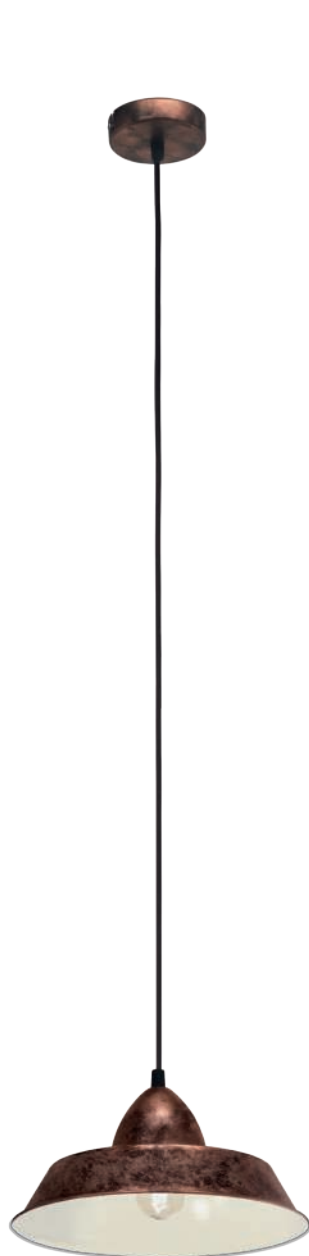

49243



49235

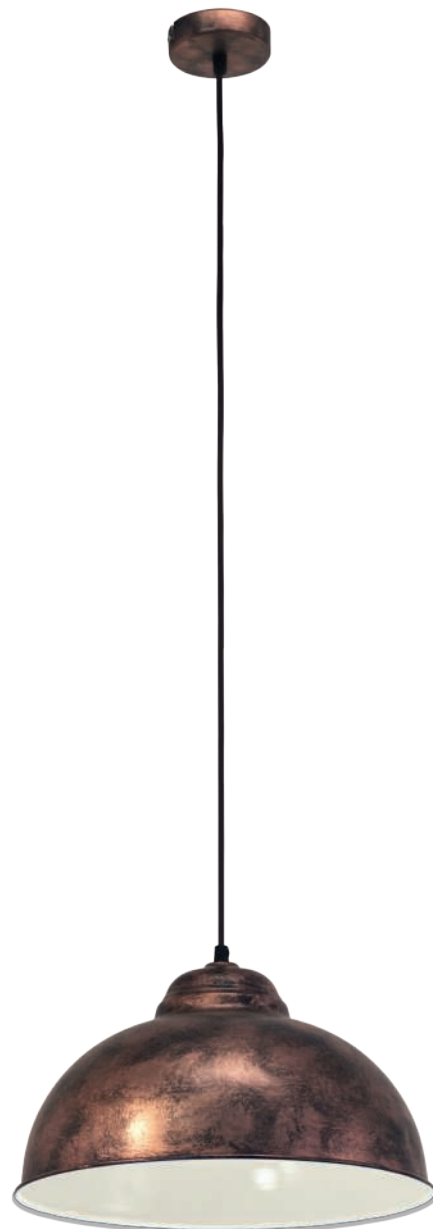

49248

### 49243 AUCKLAND

pendant light; steel, copper-coloured antique  
Hängeleuchte; Stahl, kupferfarben-antik  
luminaire en suspension; acier, cuivré antique

H 1100, Ø 260



E27 1x 60W



9 002759 492434

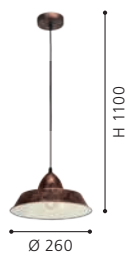

### 49235 TRURO

pendant light; steel, copper-coloured antique  
Hängeleuchte; Stahl, kupferfarben-antik  
luminaire en suspension; acier, cuivré antique

H 1100, Ø 155



E27 1x 40W



9 002759 492359

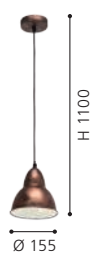

### 49248 TRURO 2

pendant light; steel, copper-coloured antique  
Hängeleuchte; Stahl, kupferfarben-antik  
luminaire en suspension; acier, cuivré antique

H 1100, Ø 370



E27 1x 60W



9 002759 492489





49492

### 49492 PRIDDY 1

pendant light; steel, copper-coloured antique  
Hängeleuchte; Stahl, kupferfarben-antik  
luminaire en suspension; acier, cuivré antique

H 1100, Ø 155



E27



1x 40W



9 002759 494926

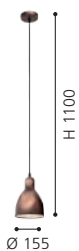



49464

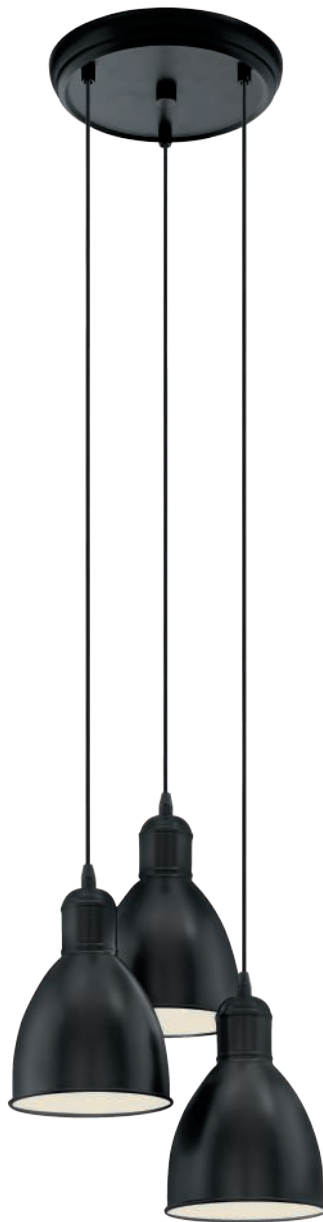

49465

### 49464 PRIDDY

pendant light; steel, black, white  
Hängeleuchte; Stahl, schwarz, weiss  
luminaire en suspension; acier, noir, blanc

H 1100, Ø 155



E27 1x 40W



9 002759 494643



### 49465 PRIDDY

pendant light; steel, black, white  
Hängeleuchte; Stahl, schwarz, weiss  
luminaire en suspension; acier, noir, blanc

H 1100, Ø 325

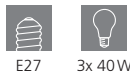

E27 3x 40W



9 002759 494650



### 49466 PRIDDY

pendant light; steel, black, white  
Hängeleuchte; Stahl, schwarz, weiss  
luminaire en suspension; acier, noir, blanc

L 975, B 155, H 1100



E27 4x 40W



9 002759 494667

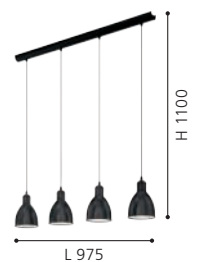





49466





49468



49469

### 49468 PRIDDY

wall light; steel, black, white  
Wandleuchte; Stahl, schwarz, weiss  
applique; acier, noir, blanc

L 130, H 215, A 200



E27 1x 40W



9 002759 494681



### 49469 PRIDDY

table light; steel, black, white  
Tischleuchte; Stahl, schwarz, weiss  
luminaire de table; acier, noir, blanc

H 425, Base: Ø 155



E27 1x 40W



9 002759 494698



### 49471 PRIDDY

floor light; steel, black, white  
Stehleuchte; Stahl, schwarz, weiss  
lampadaire; acier, noir, blanc

H 1370, Base: Ø 230



E27 1x 40W



9 002759 494711

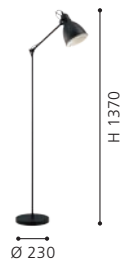



49471



#### DETAIL 43184

The luminaire can be individually extended by the movable and extendable arm.

Die Leuchte kann durch den beweglichen und ausziehbaren Arm individuell verlängert werden.

Le luminaire peut être prolongé individuellement par le bras mobile et extensible.



#### 43184 TREBURLEY

wall light; steel, black, gold  
Wandleuchte; Stahl, schwarz, gold  
applique; acier, noir, or

L 155, B 650, H 200



E27



1x 28W



9 002759 431846



#### 43353 COVALEDA 1

pendant light; steel, black, gold  
Hängeleuchte; Stahl, schwarz, gold  
luminaire en suspension; acier, noir, or

H 1370, Ø 455



E27



1x 60W



9 002759 433536

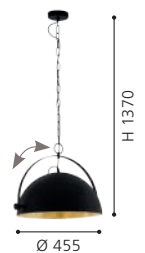



43353



49617

49618



49877

DESIGN  
HIGHLIGHT  
DETAIL



### 49617 COVALEDA

table light; wood, steel, black, brass, gold  
Tischleuchte; Holz, Stahl, schwarz, messing, gold  
luminaire de table; bois, acier, noir, laiton, or

H 735, Ø 380



E27 1x 60W



Ø 380

H 735



9 002759 496173

### 49618 COVALEDA

floor light; wood, steel, black, brass, gold  
Stehleuchte; Holz, Stahl, schwarz, messing, gold  
lampadaire; bois, acier, noir, laiton, or

H 1640, Ø 550



E27 1x 60W



Ø 550

H 1640



9 002759 496180

### 49877 COVALEDA

floor light; wood, steel, white, chrome, silver  
Stehleuchte; Holz, Stahl, weiss, chrom, silber  
lampadaire; bois, acier, blanc, chrome, argent

H 1640, Ø 550

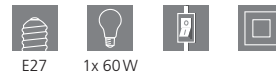

E27 1x 60W

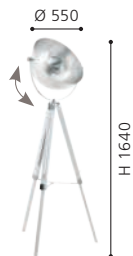

Ø 550

H 1640



9 002759 498771



DESIGN  
HIGHLIGHT  
DETAIL



49761

### 49761 EMBLETON

pendant light; steel, black  
Hängeleuchte; Stahl, schwarz  
luminaire en suspension; acier, noir

H 1100, Ø 305



E27 1x 60W



9 002759 497613

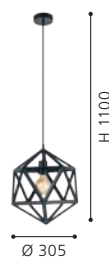

### 49762 EMBLETON

pendant light; steel, black  
Hängeleuchte; Stahl, schwarz  
luminaire en suspension; acier, noir

H 1500, Ø 460

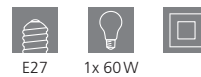

E27 1x 60W



9 002759 497620

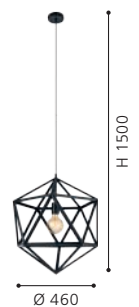





49762





#### DETAIL MARDYKE

This luminaire series has a unique look with the mixture of steel and clear glass.

Diese Leuchtenserie verfügt mit der Mischung aus Stahl und Klarglas über eine einzigartige Optik.

Cette série de luminaires a un look unique avec le mélange d'acier et de verre transparent.

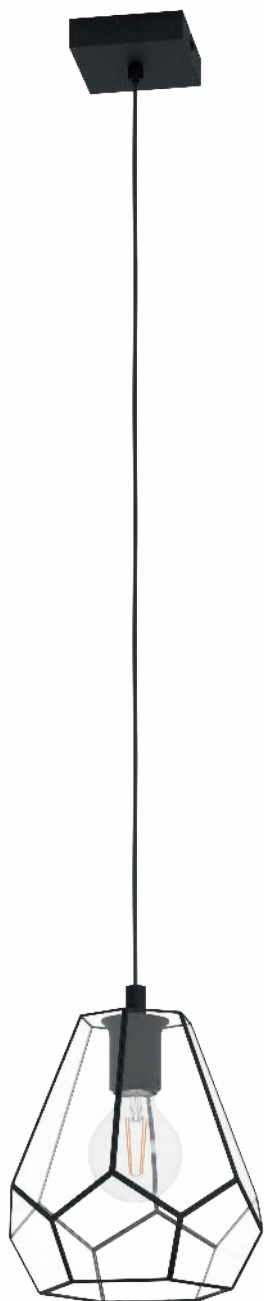

43643



43645



43646

#### 43643 MARDYKE

pendant light; steel, black / glass, clear  
Hängeleuchte; Stahl, schwarz / Glas, klar  
luminaire en suspension; acier, noir / verre, transparent

H 1100, Ø 230



E27



1x 40W



9 002759 436438



#### 43645 MARDYKE

wall light; steel, black / glass, clear  
Wandleuchte; Stahl, schwarz / Glas, klar  
applique; acier, noir / verre, transparent

L 145, H 205, A 195



E27



1x 40W



9 002759 436452

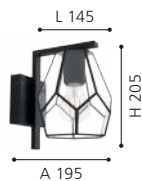

#### 43646 MARDYKE

table light; steel, black / glass, clear  
Tischleuchte; Stahl, schwarz / Glas, klar  
luminaire de table; acier, noir / verre, transparent

L 190, B 150, H 505, Base: B 188, T 128



E27



1x 40W



9 002759 436469





43644

### 43644 MARDYKE

pendant light; steel, black / glass, clear

Hängeleuchte; Stahl, schwarz / Glas, klar

luminaire en suspension; acier, noir / verre, transparent

L 775, B 145, H 1100



E27



3x 40W



9 002759 436445

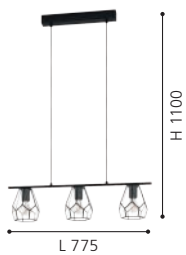

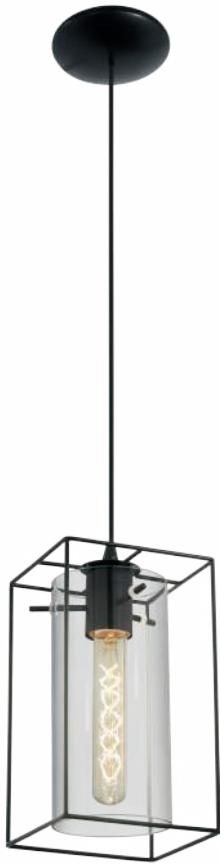

49495



49496

### 49495 LONCINO

pendant light; steel, black / smoked glass, black-transparent  
 Hängeleuchte; Stahl, schwarz / Rauchglas, schwarz-transparent  
 luminaire en suspension; acier, noir / verre fumé, noir transparent

L 150, B 150, H 1100



E27 1x 60W



### 49496 LONCINO

pendant light; steel, black / smoked glass, black-transparent  
 Hängeleuchte; Stahl, schwarz / Rauchglas, schwarz-transparent  
 luminaire en suspension; acier, noir / verre fumé, noir transparent

L 745, B 150, H 1100



E27 3x 60W





49392



49394



49393

### 49392 CHARTERHOUSE

ceiling light; steel, black / glass, clear  
Deckenleuchte; Stahl, schwarz / Glas, klar  
plafonnier; acier, noir / verre, transparent

L 360, B 360, H 160



E27



2x 60W



9 002759 493929

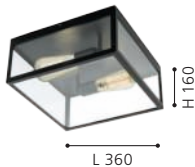

### 49394 CHARTERHOUSE

wall light; steel, black / glass, clear  
Wandleuchte; Stahl, schwarz / Glas, klar  
applique; acier, noir / verre, transparent

L 160, H 280, A 150



E27



1x 60W



9 002759 493943



### 49393 CHARTERHOUSE

pendant light; steel, black / glass, clear  
Hängeleuchte; Stahl, schwarz / Glas, klar  
luminaire en suspension; acier, noir / verre, transparent

L 730, B 200, H 1100



E27



3x 60W



9 002759 493936





49564

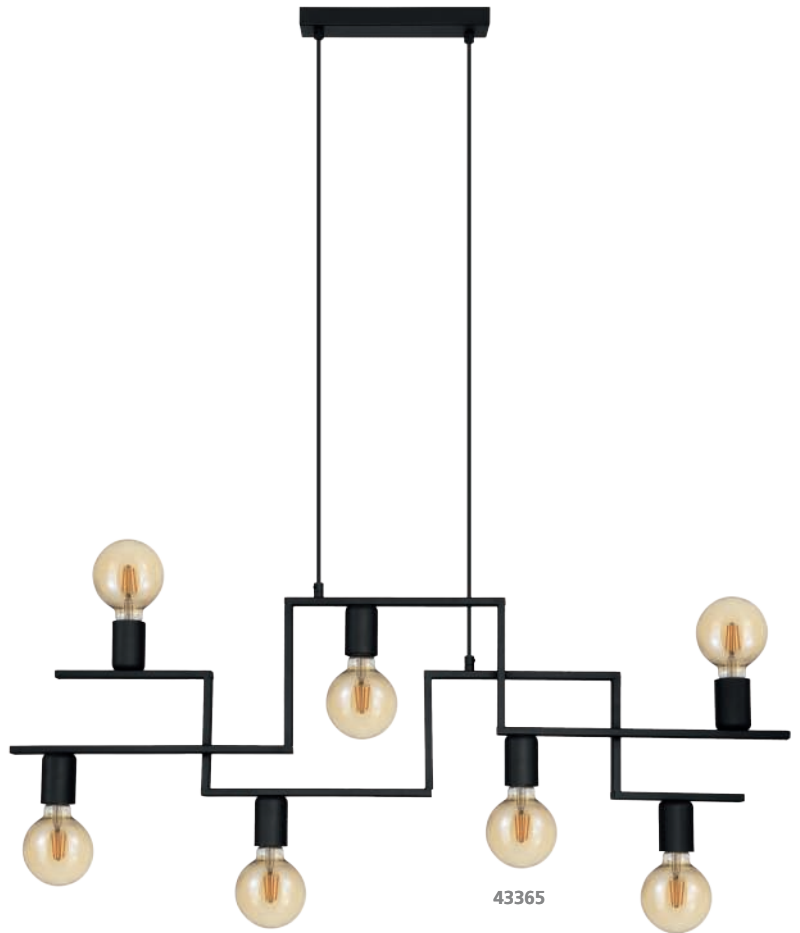

43365

### 49564 ELSWICK

pendant light; steel, black  
Hängeleuchte; Stahl, schwarz  
luminaire en suspension; acier, noir

L 1100, B 250, H 1500



E27



3x 60W



9 002759 495640



### 43365 FEMBAR

pendant light; steel, black  
Hängeleuchte; Stahl, schwarz  
luminaire en suspension; acier, noir

L 1005, B 40, H 1100



E27



7x 60W



9 002759 433659

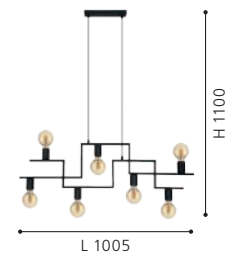



43126



#### DETAIL EXMOOR

The arms of the luminaire are individually adjustable.

Die Arme der Leuchte sind individuell einstellbar.

Les bras du luminaire sont réglables individuellement.



49037

#### 43126 WILMCOTE

ceiling light; steel, black  
Deckenleuchte; Stahl, schwarz  
plafonnier; acier, noir

H 380, Ø 280



E27



3x 60W



9 002759 431266



#### 49037 EXMOOR

ceiling light; steel, black  
Deckenleuchte; Stahl, schwarz  
plafonnier; acier, noir

H 400, Ø 960



E27



8x 60W



9 002759 490379

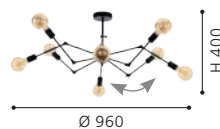



49684



49685

### 49684 OLDBURY

pendant light; steel, wood, black, brown rustic  
 Hängeleuchte; Stahl, Holz, schwarz, braun rustikal  
 luminaire en suspension; acier, bois, noir, marron rustique

L 860, B 260, H 1100



E27



2x 60W



9 002759 496845



### 49685 OLDBURY

pendant light; steel, wood, black, brown rustic  
 Hängeleuchte; Stahl, Holz, schwarz, braun rustikal  
 luminaire en suspension; acier, bois, noir, marron rustique

L 1180, B 260, H 1100



E27



3x 60W



9 002759 496852







49809



43522



43152

### 49809 PORT SETON

pendant light; steel, antique-brown  
Hängeleuchte; Stahl, antik-braun  
luminaire en suspension; acier, marron antique

H 1100, Ø 130



E27



1x 60W



9 002759 498092

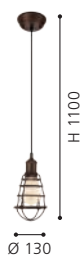

H 1100

Ø 130

### 43522 TOWNSHEND 4

ceiling light; steel, antique-brown  
Deckenleuchte; Stahl, antik-braun  
plafonnier; acier, marron antique

L 550, B 140, H 260



E27



3x 60W



9 002759 435226

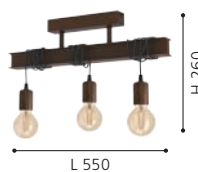

H 260

L 550

### 43152 TOWNSHEND 4

wall light; steel, black, brown  
Wandleuchte; Stahl, schwarz, braun  
applique; acier, noir, marron

L 80, H 190, A 185



E27



1x 10W



9 002759 431525



L 80

H 190

A 185

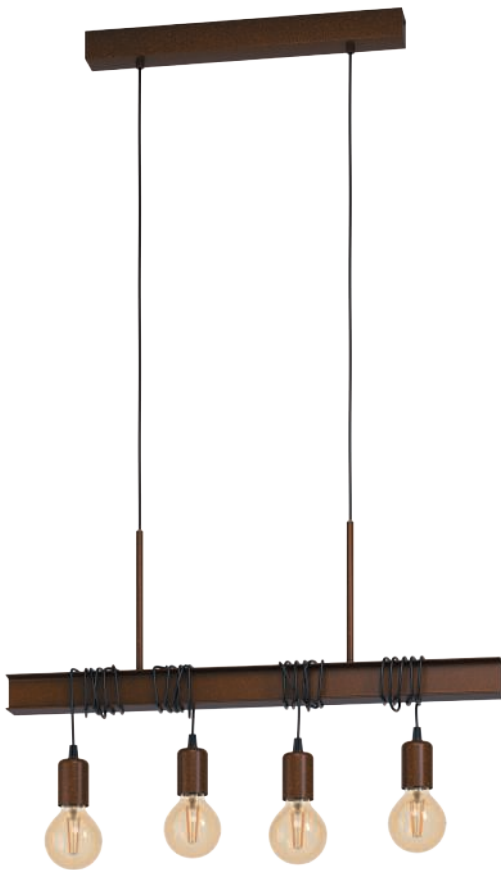

43523



43524



#### DETAIL TOWNSHEND 4

Thanks to the long cable of the luminaire heads the height can be adjusted individually.

Durch das lange Kabel der Leuchtenköpfe kann die Höhe individuell eingestellt werden.

Grâce au long câble des têtes de luminaire la hauteur peut être réglée individuellement.

#### 43523 TOWNSHEND 4

pendant light; steel, antique-brown, black  
Hängeleuchte; Stahl, antik-braun, schwarz  
luminaire en suspension; acier, marron antique, noir

L 700, B 140, H 1100



E27



4x 60W



9 002759 435233



#### 43524 TOWNSHEND 4

pendant light; steel, antique-brown, black  
Hängeleuchte; Stahl, antik-braun, schwarz  
luminaire en suspension; acier, marron antique, noir

L 1500, B 140, H 1100



E27



8x 60W



9 002759 435240

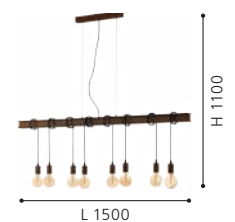

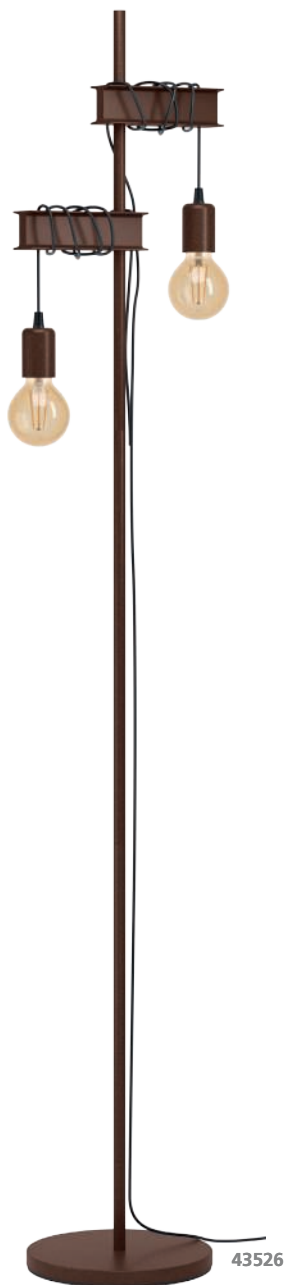

43526



49859



43525

### 43526 TOWNSHEND 4

floor light; steel, antique-brown, black  
Stehleuchte; Stahl, antik-braun, schwarz  
lampadaire; acier, marron antique, noir

L 260, B 250, H 1690, Base: Ø 250



E27 2x 10W



9 002759 435264

### 43525 TOWNSHEND 4

table light; steel, antique-brown, black  
Tischleuchte; Stahl, antik-braun, schwarz  
luminaire de table; acier, marron antique, noir

L 165, B 155, H 500, Base: Ø 155



E27 1x 10W



9 002759 435257

### 49859 TOWNSHEND 4

pendant light; steel, antique-brown  
Hängeleuchte; Stahl, antik-braun  
luminaire en suspension; acier, marron antique

L 1005, B 70, H 1100



E27 6x 60W



9 002759 498597



43733



### 43733 PRESTWICK 2

table light; wood, brown  
Tischleuchte; Holz, braun  
luminaire de table; bois, marron

L 95, B 95, H 95



E27



1x 40W



9 002759 437336





43549



43548



43734



### 43548 PRESTWICK 1

table light; steel, auburn  
Tischleuchte; Stahl, rostbraun  
luminaire de table; acier, brun rouille

L 100, B 100, H 100



E27 1x 40W



9 002759 435486



### 43549 PRESTWICK 2

table light; steel, dark bronze  
Tischleuchte; Stahl, bronze dunkel  
luminaire de table; acier, bronze foncé

L 100, B 100, H 100



E27 1x 40W



9 002759 435493



### 43734 PRESTWICK 2

table light; wood, black  
Tischleuchte; Holz, schwarz  
luminaire de table; bois, noir

L 95, B 95, H 95



E27 1x 40W



9 002759 437343





49076



49077



49078

### 49076 GATEBECK

spot; wood, natural / steel, black  
Spot; Holz, natur / Stahl, schwarz  
spot; bois, naturel / acier, noir

L 110, B 110, H 205



E14 1x 40W



9 002759 490768



### 49077 GATEBECK

spot; wood, natural / steel, black  
Spot; Holz, natur / Stahl, schwarz  
spot; bois, naturel / acier, noir

L 360, B 110, H 205

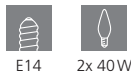

E14 2x 40W



9 002759 490775

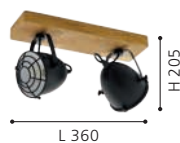

### 49078 GATEBECK

spot; wood, natural / steel, black  
Spot; Holz, natur / Stahl, schwarz  
spot; bois, naturel / acier, noir

L 590, B 110, H 205

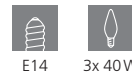

E14 3x 40W



9 002759 490782





49079

### 49079 GATEBECK

spot; wood, natural / steel, black  
Spot; Holz, natur / Stahl, schwarz  
spot; bois, naturel / acier, noir

L 300, B 300, H 205



E14



4x 40W



9 002759 490799

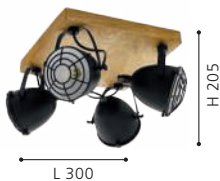



### 43468 LAYHAM

pendant light; wood, steel, brown, black  
 Hängeleuchte; Holz, Stahl, braun, schwarz  
 luminaire en suspension; bois, acier, marron, noir

L 960, B 85, H 1100



E27 5x 60W



9 002759 434687

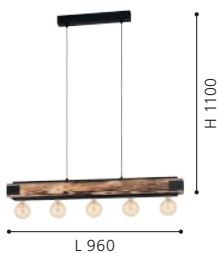

### 43466 LAYHAM

ceiling light; wood, steel, brown, black  
 Deckenleuchte; Holz, Stahl, braun, schwarz  
 plafonnier; bois, acier, marron, noir

L 760, B 85, H 100



E27 4x 60W



9 002759 434663



### 43469 LAYHAM

table light; wood, steel, brown, black  
 Tischleuchte; Holz, Stahl, braun, schwarz  
 luminaire de table; bois, acier, marron, noir

L 200, B 85, H 100

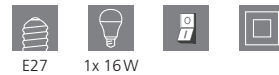

E27 1x 16W



9 002759 434694







43469



### 43471 LAYHAM

floor light; wood, steel, brown, black  
 Stehleuchte; Holz, Stahl, braun, schwarz  
 lampadaire; bois, acier, marron, noir

H 1275, Base: B 260, T 245



E27



4x 60W



9 002759 434717



43471





43159



43805

### 43159 HARBOROUGH

pendant light; steel, black / wood, brown  
 Hängeleuchte; Stahl, schwarz / Holz, braun  
 luminaire en suspension; acier, noir / bois, marron

L 900, B 125, H 1100



E27



4x 40W



9 002759 431594

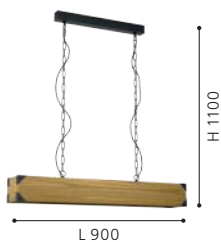

### 43805 EVESHAM

pendant light; steel, wood, black, brown  
 Hängeleuchte; Stahl, Holz, schwarz, braun  
 luminaire en suspension; acier, bois, noir, marron

L 890, B 190, H 1100



E27



3x 40W



9 002759 438050

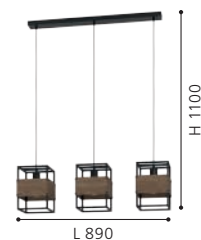



43804



43807



43806



### 43804 EVESHAM

ceiling light; steel, wood, black, brown  
Deckenleuchte; Stahl, Holz, schwarz, braun  
plafonnier; acier, bois, noir, marron

L 870, B 190, H 250



E27



3x 40W



9 002759 438043



L 870

H 250

### 43807 EVESHAM

table light; steel, wood, black, brown  
Tischleuchte; Stahl, Holz, schwarz, braun  
luminaire de table; acier, bois, noir, marron

L 190, B 180, H 250



E27



1x 40W



9 002759 438074



L 190

H 250

### 43806 EVESHAM

wall light; steel, wood, black, brown  
Wandleuchte; Stahl, Holz, schwarz, braun  
applique; acier, bois, noir, marron

L 140, H 240, A 170



E27



1x 40W



9 002759 438067



A 170

H 240



43832

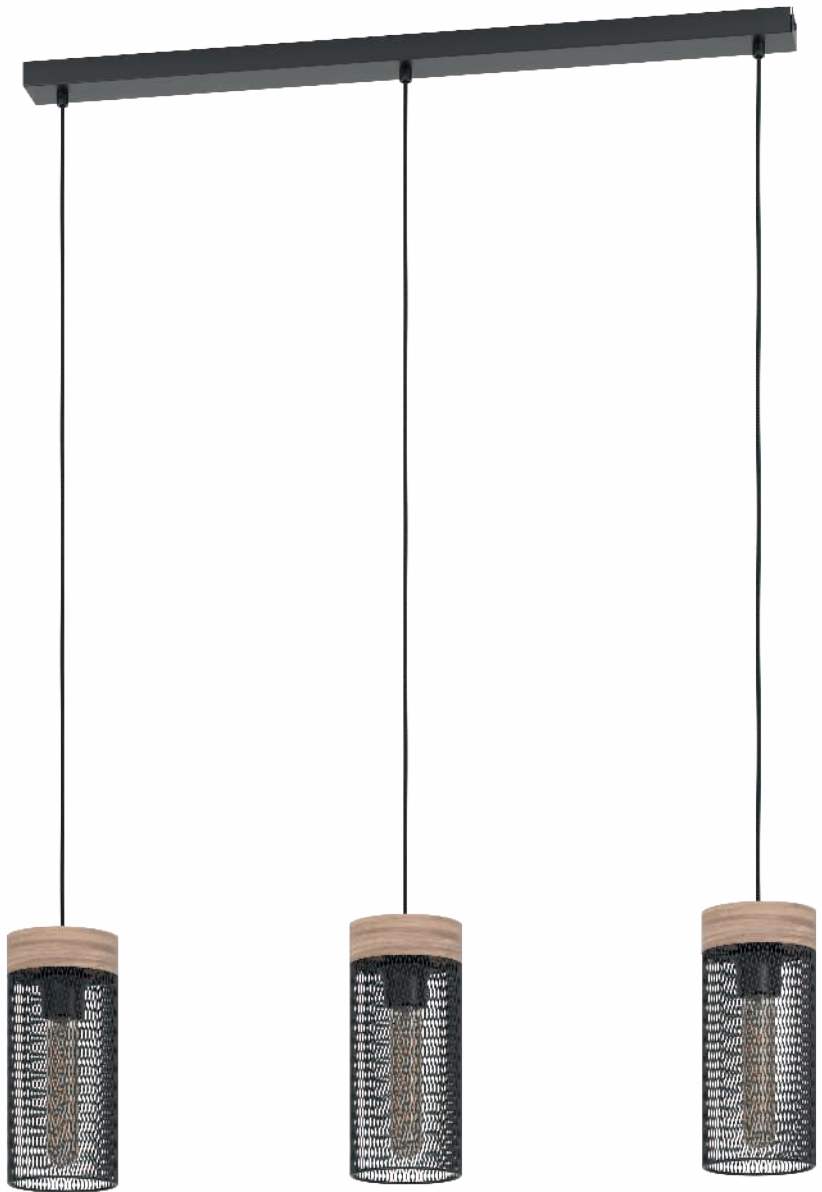

43834

### 43832 KILNSDALE

ceiling light; steel, wood, black, brown  
Deckenleuchte; Stahl, Holz, schwarz, braun  
plafonnier; acier, bois, noir, marron

H 240, Ø 380



E27 1x 40W



9 002759 438326

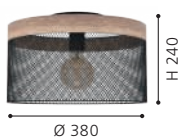

### 43834 KILNSDALE

pendant light; steel, wood, black, brown  
Hängeleuchte; Stahl, Holz, schwarz, braun  
luminaire en suspension; acier, bois, noir, marron

L 810, B 110, H 1100



E27 3x 40W



9 002759 438340

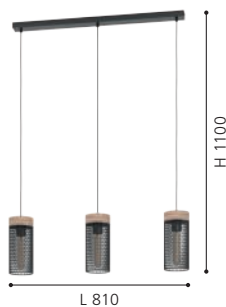

### 43833 KILNSDALE

pendant light; steel, wood, black, brown  
Hängeleuchte; Stahl, Holz, schwarz, braun  
luminaire en suspension; acier, bois, noir, marron

H 1100, Ø 110



E27 1x 40W



9 002759 438333





43833

# LOFT

Separate rooms and designated spaces for working, eating and leisure are a thing of the past. Free spirits need open spaces. The loft design imparts a sense of freedom and tranquillity, and the minimalist furnishings and accessories ensure your space still feels cosy and liveable. Simple yet sophisticated. Clean lines and dark surfaces offset by brighter accents are the main features of the loft aesthetic. Recreate this chic look in your own home with EGLO.

Die Zeiten in denen Wohnen, Essen und Arbeiten in getrennten Räumen stattfanden, sind vorbei. Freigeister brauchen Freiräume, um sich wohl zu fühlen. Der Loft-Look steht für Freiheit und Gelassenheit, welcher durch minimalistische Möbel und Accessoires trotzdem gemütliches Raumgefühl gibt. Einfach und doch raffiniert. Klare Linien, dunkle Oberflächen, kontrastiert von hellen Akzenten sind die Hauptmerkmale des Loft-Looks und mit EGLO holen Sie sich diesen Loft-Charm ganz einfach nach Hause.

Finie l'époque où l'on vivait, mangeait et travaillait dans des pièces distinctes ! Les esprits libres ont besoin d'espace pour se sentir bien. Le style loft est synonyme de liberté et de sérénité, mais donne néanmoins le sentiment d'un espace chaleureux grâce à un mobilier et à des accessoires minimalistes. Simple, mais sophistiqué. Des lignes épurées avec des surfaces foncées, contrastées par des touches claires, sont les principales caractéristiques du style loft. Appropriiez-vous son élégance dans votre intérieur avec EGLO.



CHASELY  
p. 78



HORNWOOD 2  
p. 79



MADRESELVA  
p. 80



BOYLE  
p. 80-81

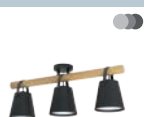

HORNWOOD  
p. 82-83

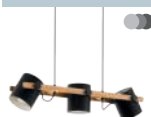

LACEY  
p. 84-85

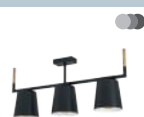

BRAMERTON  
p. 86-87

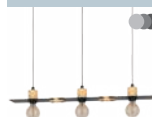

AYLES  
p. 87

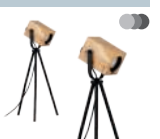

<b>CHIEVELEY</b> p. 88-89	<b>HALKIN</b> p. 90	<b>CONSETT</b> p. 90-91	<b>MONMOUNT</b> p. 92	<b>FAMBOROUGH</b> p. 92-93	<b>NAFFERTON</b> p. 94-95	<b>LITTLETON</b> p. 96-97	<b>IPSDEN</b> p. 98
<b>BASILDON 1</b> p. 98	<b>BASILDON</b> p. 100-101	<b>CALLOW</b> p. 102	<b>SHERBURN</b> p. 103	<b>TOWNSHEND</b> p. 104-109	<b>TOWNSHEND 5</b> p. 109-111	<b>PALMORLA</b> p. 112	<b>DISTAFF</b> p. 113
<b>CARLTON 1</b> p. 114-116, 120-122	<b>CARLTON 7</b> p. 116-117	<b>CARLTON 4</b> p. 118	<b>CARLTON 6</b> p. 118	<b>CARLTON 5</b> p. 119-120	<b>CARLTON-P</b> p. 122-123	<b>CARLTON</b> p. 125-127	<b>STYPE</b> p. 128-129
<b>STRAITON</b> p. 130-131, 172-173	<b>VERNHAM</b> p. 133	<b>TARBES</b> p. 134, 144-145, 147-151	<b>CARLTON 2</b> p. 134-135	<b>STILLINGTON</b> p. 136-137	<b>MUMBLES</b> p. 139	<b>SOUTHERY</b> p. 140-141	<b>CASTANUELO</b> p. 142-143
<b>TARBES 2</b> p. 146	<b>ROCCAMENA</b> p. 152-153	<b>CLEVEDON</b> p. 154	<b>NEWTOWN</b> p. 156-157	<b>AUSTELL</b> p. 158-159	<b>PLIMSOLL</b> p. 161	<b>HORNWOOD 1</b> p. 162-163	<b>GLASTONBURY</b> p. 164
<b>BIDFORD</b> p. 164-165	<b>LANTADA</b> p. 165	<b>CHESTER</b> p. 167	<b>CHESTER 1</b> p. 167	<b>CHESTER-P</b> p. 168	<b>DUNDEE</b> p. 168	<b>COPLEY</b> p. 170-171	<b>CORETTO 2</b> p. 172
<b>HAPTON</b> p. 173	<b>WRINGTON</b> p. 174-175	<b>WRINGTON 1</b> p. 176-177	<b>POMPEYA</b> p. 178-179	<b>BAZELY</b> p. 181	<b>SALLICANO</b> p. 181	<b>TWICKEN</b> p. 182-183	<b>MATLOCK</b> p. 184-187
<b>GIACONECCHIA</b> p. 188-189	<b>PRESTWICK 3</b> p. 190-191	<b>PRESTWICK</b> p. 192	<b>LYNTON</b> p. 192	<b>FRIJOLAS</b> p. 192			



This product is available in different colors and shapes./ Dieser Artikel ist in unterschiedlichen Farben und Formen verfügbar.  
Cet article est disponible en différentes couleurs et formes.



43459

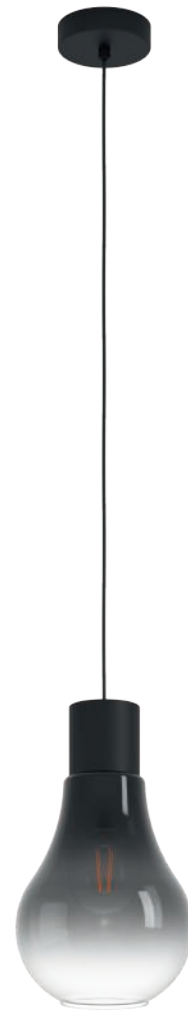

43129

#### DETAIL CHASELY

The glass shade of this luminaire has a unique color gradient.  
 Der Glasschirm dieser Leuchte hat einen einzigartigen Farbverlauf.  
 L'abat-jour en verre de cette luminaire a un dégradé de couleurs unique.



#### 43459 CHASELY

pendant light; steel, black / glass, black-brown-transparent  
 Hängeleuchte; Stahl, schwarz / Glas, schwarz-braun-transparent  
 luminaire en suspension; acier, noir / verre, noir-marron-transparent

H 1100, Ø 200



E27 1x 40W



9 002759 434595



#### 43129 CHASELY

pendant light; steel, black / glass, black-grey-transparent  
 Hängeleuchte; Stahl, schwarz / Glas, schwarz-grau-transparent  
 luminaire en suspension; acier, noir / verre, noir-gris-transparent

H 1100, Ø 200



E27 1x 40W



9 002759 431297





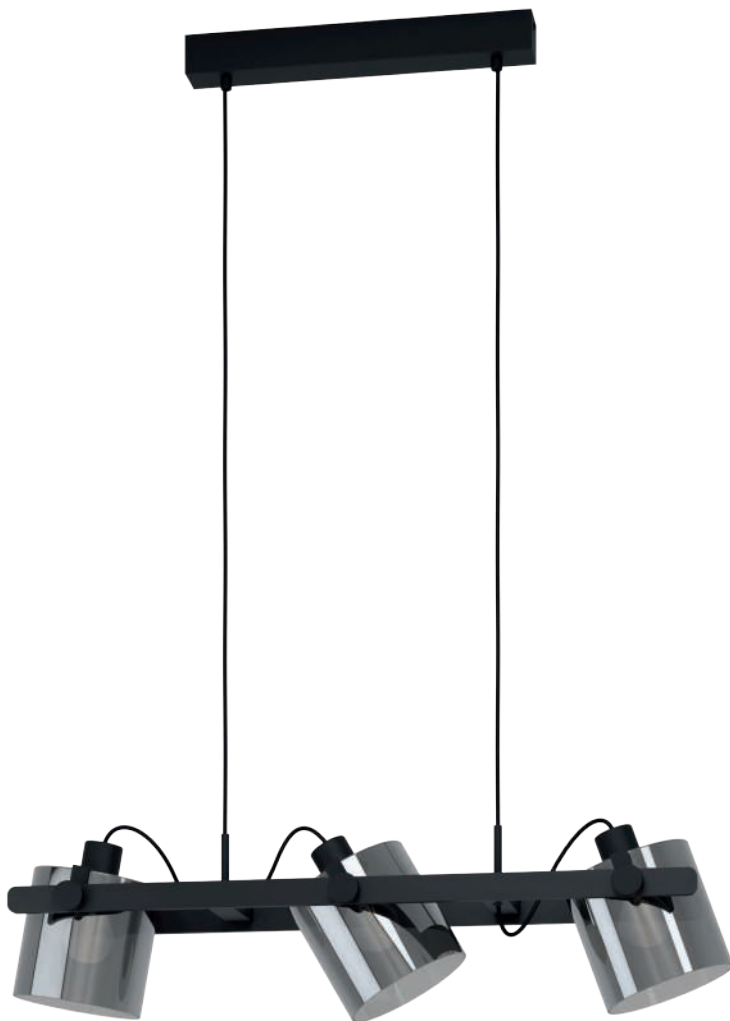

43606



43671



### 43606 HORNWOOD 2

pendant light; steel, wood, black / glass vaporized, black-transparent

Hängeleuchte; Stahl, Holz, schwarz / Glas bedampft, schwarz-transparent

luminaire en suspension; acier, bois, noir / verre vaporisé, noir transparent

L 780, B 150, H 1100



E27



3x 40W



9 002759 436063

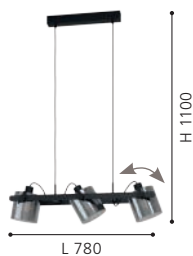

### 43671 HORNWOOD 2

ceiling light; steel, wood, black / glass vaporized, black-transparent

Deckenleuchte; Stahl, Holz, schwarz / Glas bedampft, schwarz-transparent

plafonnier; acier, bois, noir / verre vaporisé, noir transparent

L 1110, B 225, H 265



E27



4x 40W



9 002759 436711

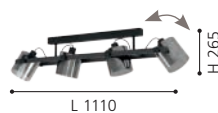

### DETAIL HORNWOOD 2

The heads of this luminaire can be swiveled individually.

Die Leuchtenköpfe sind individuell schwenkbar.

Les têtes de ce luminaire peuvent être pivotées individuellement.





43545

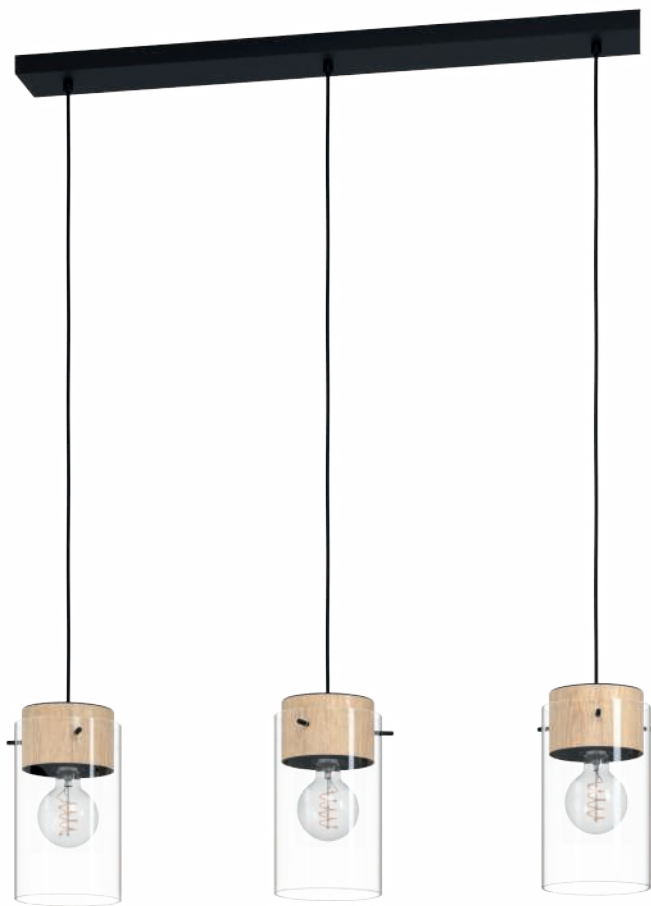

43546



43635



### 43545 MADRESELVA

pendant light; steel, black / wood, glass, brown, clear  
Hängeleuchte; Stahl, schwarz / Holz, Glas, braun, klar  
luminaire en suspension; acier, noir / bois, verre, marron, transparent

H 1100, Ø 140



E27 1x 28W



9 002759 435455

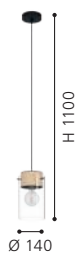

### 43546 MADRESELVA

pendant light; steel, black / wood, glass, brown, clear  
Hängeleuchte; Stahl, schwarz / Holz, Glas, braun, klar  
luminaire en suspension; acier, noir / bois, verre, marron, transparent

L 1190, B 140, H 1100



E27 3x 28W



9 002759 435462



### 43635 BOYLE

ceiling light; steel, wood, black, brown / plastic, white  
Deckenleuchte; Stahl, Holz, schwarz, braun / Kunststoff, weiss  
plafonnier; acier, bois, noir, marron / plastique, blanc

L 780, B 170, H 300



E27 3x 10W



9 002759 436353





43636



### 43636 BOYLE

pendant light; steel, wood, black, brown / plastic, white  
Hängeleuchte; Stahl, Holz, schwarz, braun / Kunststoff, weiss  
luminaire en suspension; acier, bois, noir, marron / plastique, blanc

L 780, B 170, H 1100



E27



3x 10W



9 002759 436360

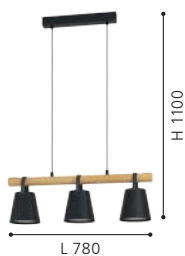



43045



43424



#### DETAIL HORNWOOD

The heads can be adjusted or fixed in position with the lateral screws.  
 Die Köpfe können mittels den seitlichen Schrauben verstellt oder fixiert werden.  
 Les têtes peuvent être réglées ou fixées à l'aide des vis latérales.



43046

#### 43045 HORNWOOD

pendant light; steel, black, creme / wood, brown  
 Hängeleuchte; Stahl, schwarz, creme / Holz, braun  
 luminaire en suspension; acier, noir, crème / bois, marron

L 780, B 210, H 1100



E27 3x 60W



9 002759 430450

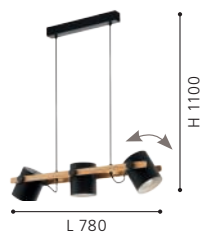

#### 43424 HORNWOOD

pendant light; steel, black, creme / wood, brown  
 Hängeleuchte; Stahl, schwarz, creme / Holz, braun  
 luminaire en suspension; acier, noir, crème / bois, marron

L 1100, B 180, H 1100



E27 4x 28W



9 002759 434243

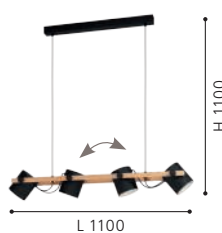

#### 43046 HORNWOOD

wall light; steel, black, creme / wood, brown  
 Wandleuchte; Stahl, schwarz, creme / Holz, braun  
 applique; acier, noir, crème / bois, marron

Ø 170



E27 1x 28W



9 002759 430467





43558



43047



43048

### 43558 HORNWOOD

ceiling light; steel, black, creme / wood, brown  
Deckenleuchte; Stahl, schwarz, creme / Holz, braun  
plafonnier; acier, noir, crème / bois, marron

L 1000, B 190, H 275



E27



4x 28W



9 002759 435585

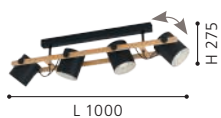

### 43047 HORNWOOD

table light; steel, black, creme / wood, brown  
Tischleuchte; Stahl, schwarz, creme / Holz, braun  
luminaire de table; acier, noir, crème / bois, marron

L 210, B 180, H 420, Base: Ø 180



E27



1x 28W



9 002759 430474

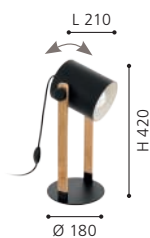

### 43048 HORNWOOD

floor light; steel, black, creme / wood, brown  
Stehleuchte; Stahl, schwarz, creme / Holz, braun  
lampadaire; acier, noir, crème / bois, marron

L 230, B 230, H 1400, Base: Ø 230



E27



1x 28W



9 002759 430481

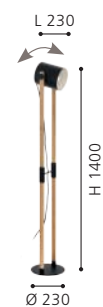



43612



43611



#### DETAIL LACEY

This luminaire has design elements made of real wood.

Diese Leuchte verfügt über Design-elemente aus Echtholz.

Cette luminaire a des éléments de design en bois véritable.

#### 43612 LACEY

pendant light; steel, wood, black, brown / steel, black, creme  
Hängeleuchte; Stahl, Holz, schwarz, braun / Stahl, schwarz, creme

luminaire en suspension; acier, bois, noir, marron / acier, noir, crème

L 780, B 160, H 1100



E27



3x 40W



9 002759 436124

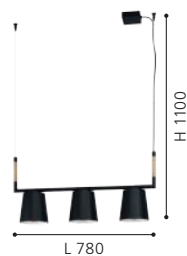

#### 43611 LACEY

ceiling light; steel, wood, black, brown / steel, black, creme  
Deckenleuchte; Stahl, Holz, schwarz, braun / Stahl, schwarz, creme

plafonnier; acier, bois, noir, marron / acier, noir, crème

L 780, B 160, H 335



E27



3x 40W



9 002759 436117





43735



43613



43614



### 43735 LACEY

wall light; steel, wood, black, brown / steel, black, creme  
 Wandleuchte; Stahl, Holz, schwarz, braun / Stahl, schwarz, creme  
 applique; acier, bois, noir, marron / acier, noir, crème

L 135, H 275, A 265



E14



1x 40W



9 002759 437350



### 43613 LACEY

table light; steel, wood, black, brown / steel, black, creme  
 Tischleuchte; Stahl, Holz, schwarz, braun / Stahl, schwarz, creme  
 luminaire de table; acier, bois, noir, marron / acier, noir, crème

L 255, B 135, H 485, Base: B 170, T 120



E14



1x 40W



9 002759 436131



### 43614 LACEY

floor light; steel, wood, black, brown / steel, black, creme  
 Stehleuchte; Stahl, Holz, schwarz, braun / Stahl, schwarz, creme  
 lampadaire; acier, bois, noir, marron / acier, noir, crème

L 310, B 160, H 1595, Base: B 280, T 200



E27



1x 40W



9 002759 436148



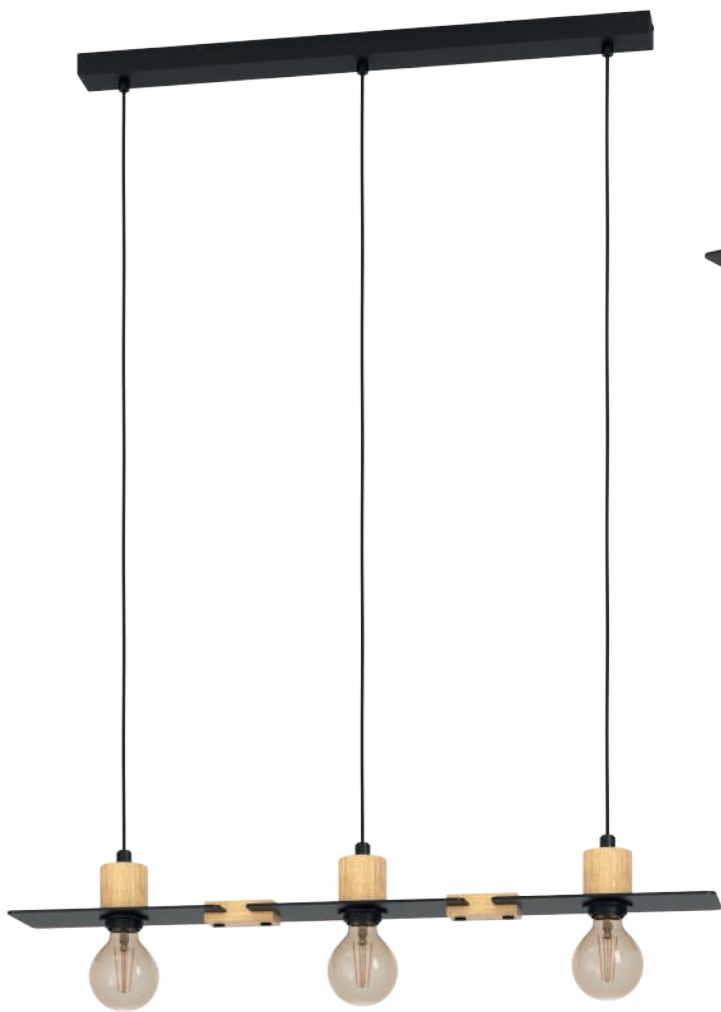

43752



43751



43753



### 43752 BRAMERTON

pendant light; steel, wood, black, brown  
Hängeleuchte; Stahl, Holz, schwarz, braun  
luminaire en suspension; acier, bois, noir, marron

L 810, B 120, H 1100



E27 3x 40W



9 002759 437527

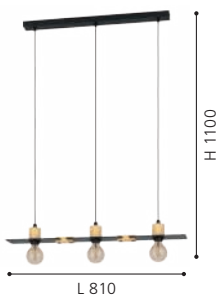

### 43751 BRAMERTON

ceiling light; steel, wood, black, brown  
Deckenleuchte; Stahl, Holz, schwarz, braun  
plafonnier; acier, bois, noir, marron

L 810, B 120, H 100



E27 3x 40W



9 002759 437510



### 43753 BRAMERTON

wall light; steel, wood, black, brown  
Wandleuchte; Stahl, Holz, schwarz, braun  
applique; acier, bois, noir, marron

L 120, H 110, A 215



E27 1x 40W



9 002759 437534

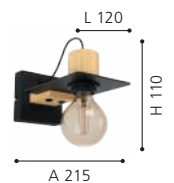





43754



43749



43748



### 43754 BRAMERTON

table light; steel, wood, black, brown  
Tischleuchte; Stahl, Holz, schwarz, braun  
luminaire de table; acier, bois, noir, marron

L 120, B 140, H 310, Base: B 120, T 140



E27



1x 40W



9 002759 437541

### 43749 AYLES

table light; steel, black / wood, brown  
Tischleuchte; Stahl, schwarz / Holz, braun  
luminaire de table; acier, noir / bois, marron

H 475, Base: Ø 260



GU10



1x 3W



1x  
250lm



9 002759 437497



### 43748 AYLES

pendant light; steel, black / wood, brown  
Hängeleuchte; Stahl, schwarz / Holz, braun  
luminaire en suspension; acier, noir / bois, marron

L 930, B 85, H 1100



GU10



4x 3W



4x  
250lm

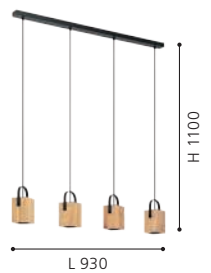

9 002759 437480





43541



43542



### 43541 CHIEVELEY

pendant light; steel, black / wood, brown  
 Hängeleuchte; Stahl, schwarz / Holz, braun  
 luminaire en suspension; acier, noir / bois, marron

L 885, B 85, H 1100



E27



5x 40W



9 002759 435417

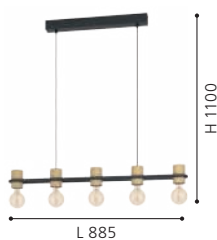

### 43542 CHIEVELEY

wall light; steel, black / wood, brown  
 Wandleuchte; Stahl, schwarz / Holz, braun  
 applique; acier, noir / bois, marron

L 285, H 90, A 115



E27



2x 40W



9 002759 435424





43543

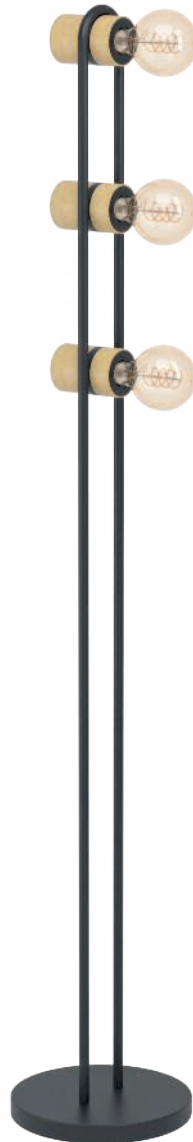

43544



### 43543 CHIEVELEY

table light; steel, black / wood, brown  
Tischleuchte; Stahl, schwarz / Holz, braun  
luminaire de table; acier, noir / bois, marron

L 85, B 90, H 410, Base: Ø 155



E27



1x 28 W



9 002759 435431

### 43544 CHIEVELEY

floor light; steel, black / wood, brown  
Stehleuchte; Stahl, schwarz / Holz, braun  
lampadaire; acier, noir / bois, marron

L 85, B 90, H 1405, Base: Ø 230



E27



3x 28 W



9 002759 435448



43799



43798



43724



### 43799 HALKIN

pendant light; wood, steel, brown, black  
 Hängeleuchte; Holz, Stahl, braun, schwarz  
 luminaire en suspension; bois, acier, marron, noir

L 720, B 250, H 1100



E27 4x 40W



9 002759 437992

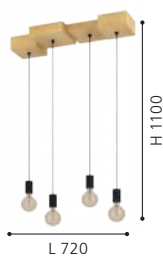

### 43798 HALKIN

ceiling light; wood, steel, brown, black  
 Deckenleuchte; Holz, Stahl, braun, schwarz  
 plafonnier; bois, acier, marron, noir

L 400, B 430, H 140



E27 4x 40W



9 002759 437985

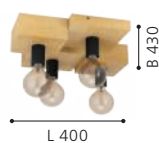

### 43724 CONSETT

ceiling light; steel, wood, black, brown  
 Deckenleuchte; Stahl, Holz, schwarz, braun  
 plafonnier; acier, bois, noir, marron

L 780, B 250, H 115



E27 6x 40W



9 002759 437244

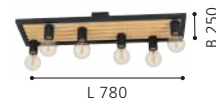



43725



### 43725 CONSETT

pendant light; steel, wood, black, brown  
 Hängeleuchte; Stahl, Holz, schwarz, braun  
 luminaire en suspension; acier, bois, noir, marron

L 780, B 250, H 1100



E27



6x 40W



9 002759 437251

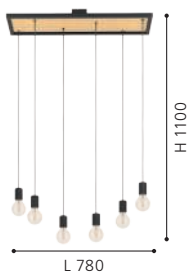

H 1100

L 780



DESIGN  
HIGHLIGHT  
DETAIL



43641

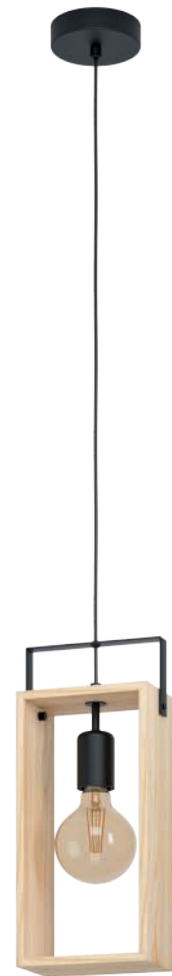

43413



### 43641 MONMOUNT

pendant light; steel, wood, black, brown  
 Hängeleuchte; Stahl, Holz, schwarz, braun  
 luminaire en suspension; acier, bois, noir, marron

L 1085, B 445, H 850



E27



9x 40W



9 002759 436414

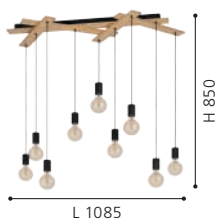

### 43413 FAMBOROUGH

pendant light; steel, wood, black, natural  
 Hängeleuchte; Stahl, Holz, schwarz, natur  
 luminaire en suspension; acier, bois, noir, naturel

L 160, B 105, H 1100



E27



1x 40W



9 002759 434137

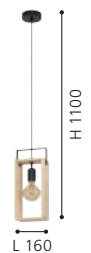



43414



43416



43415



### 43414 FAMBOROUGH

pendant light; steel, wood, black, natural  
Hängeleuchte; Stahl, Holz, schwarz, natur  
luminaire en suspension; acier, bois, noir, naturel

L 1000, B 160, H 1100



E27

5x 40W



9 002759 434144

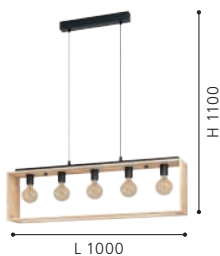

### 43416 FAMBOROUGH

table light; steel, wood, black, natural  
Tischleuchte; Stahl, Holz, schwarz, natur  
luminaire de table; acier, bois, noir, naturel

L 305, B 160, H 565, Base: B 300, T 160



E27

3x 40W



9 002759 434168



### 43415 FAMBOROUGH

table light; steel, wood, black, natural  
Tischleuchte; Stahl, Holz, schwarz, natur  
luminaire de table; acier, bois, noir, naturel

L 165, B 100, H 400, Base: B 160, T 100



E27

1x 40W



9 002759 434151





43744



### 43744 NAFFERTON

pendant light; steel, wood, black, brown  
Hängeleuchte; Stahl, Holz, schwarz, braun  
luminaire en suspension; acier, bois, noir, marron

L 800, B 100, H 1100



E27



3x 40W



9 002759 437442







43743



43746



43745



### 43743 NAFFERTON

pendant light; steel, wood, black, brown  
Hängeleuchte; Stahl, Holz, schwarz, braun  
luminaire en suspension; acier, bois, noir, marron

L 100, B 100, H 1100



E27



1x 40W



9 002759 437435



### 43746 NAFFERTON

table light; steel, wood, black, brown  
Tischleuchte; Stahl, Holz, schwarz, braun  
luminaire de table; acier, bois, noir, marron

L 100, B 100, H 280



E27



1x 40W



9 002759 437466



### 43745 NAFFERTON

wall light; steel, wood, black, brown  
Wandleuchte; Stahl, Holz, schwarz, braun  
applique; acier, bois, noir, marron

L 100, H 280, A 125



E27



1x 40W



9 002759 437459

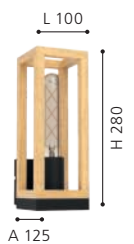



49473



49475

### 49473 LITTLETON

pendant light; steel, black / wood, brown  
Hängeleuchte; Stahl, schwarz / Holz, braun  
luminaire en suspension; acier, noir / bois, marron

L 110, B 100, H 1100



E27



1x 60W



9 002759 494735

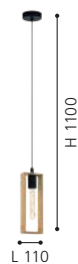

### 49475 LITTLETON

pendant light; steel, black / wood, brown  
Hängeleuchte; Stahl, schwarz / Holz, braun  
luminaire en suspension; acier, noir / bois, marron

L 1160, B 55, H 1100



E27



4x 60W



9 002759 494759





49698



49549

### 49698 LITTLETON

wall light; steel, black / wood, brown  
Wandleuchte; Stahl, schwarz / Holz, braun  
applique; acier, noir / bois, marron

L 110, H 330, A 115



E27



1x 60W



9 002759 496982



### 49549 LITTLETON

pendant light; steel, black / wood, brown  
Hängeleuchte; Stahl, schwarz / Holz, braun  
luminaire en suspension; acier, noir / bois, marron

H 1500, Ø 500



E27



6x 60W



9 002759 495497

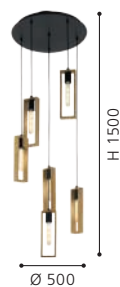



43551



43569



### 43551 IPSDEN

pendant light; steel, black / wood, brown  
 Hängeleuchte; Stahl, schwarz / Holz, braun  
 luminaire en suspension; acier, noir / bois, marron

H 1300, Ø 300



E27 3x 40W



9 002759 435516

### 43569 BASILDON 1

table light; steel, wood, black, brown / fabric, black  
 Tischleuchte; Stahl, Holz, schwarz, braun / Textil, schwarz  
 luminaire de table; acier, bois, noir, marron / tissu, noir

H 425, Ø 230, Base: Ø 150

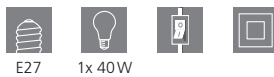

E27 1x 40W



9 002759 435691

### 43552 IPSDEN

pendant light; steel, black / wood, brown  
 Hängeleuchte; Stahl, schwarz / Holz, braun  
 luminaire en suspension; acier, noir / bois, marron

L 1005, B 220, H 1100



E27 5x 40W

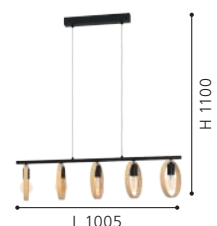

9 002759 435523



43552





### DETAIL BASILDON

The black metal ring is individually adjustable.  
Der schwarze Metallring ist individuell verstellbar.  
L'anneau en métal noir est réglable individuellement.



43461



43462



### 43461 BASILDON

pendant light; steel, wood, black, brown  
Hängeleuchte; Stahl, Holz, schwarz, braun  
luminaire en suspension; acier, bois, noir, marron

L 190, B 160, H 1100



E27 1x 40W



9 002759 434618



### 43462 BASILDON

pendant light; steel, wood, black, brown  
Hängeleuchte; Stahl, Holz, schwarz, braun  
luminaire en suspension; acier, bois, noir, marron

L 780, B 160, H 1100



E27 3x 40W



9 002759 434625





43736



43464



43463



### 43736 BASILDON

ceiling light; steel, wood, black, brown  
Deckenleuchte; Stahl, Holz, schwarz, braun  
plafonnier; acier, bois, noir, marron

H 375, Ø 320



E27



1x 40W



9 002759 437367

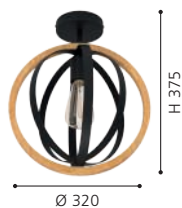

### 43464 BASILDON

table light; steel, wood, black, brown  
Tischleuchte; Stahl, Holz, schwarz, braun  
luminaire de table; acier, bois, noir, marron

L 190, B 160, H 345, Base: Ø 155



E27



1x 40W



9 002759 434649



### 43463 BASILDON

pendant light; steel, wood, black, brown  
Hängeleuchte; Stahl, Holz, schwarz, braun  
luminaire en suspension; acier, bois, noir, marron

H 1300, Ø 615



E27



3x 40W



9 002759 434632





43756

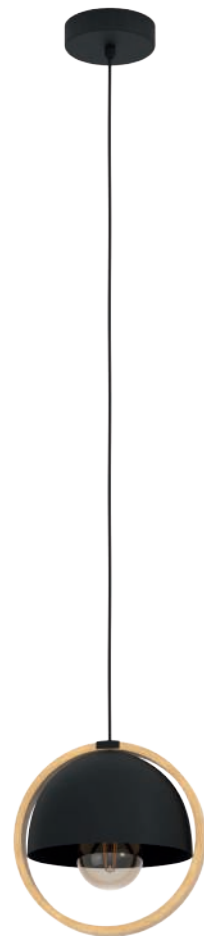

43755



### 43756 CALLOW

pendant light; steel, wood, black, brown  
 Hängeleuchte; Stahl, Holz, schwarz, braun  
 luminaire en suspension; acier, bois, noir, marron

L 930, B 230, H 1100



E27



3x 40W



9 002759 437565

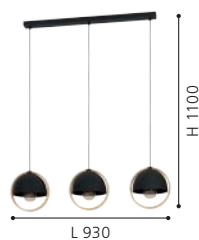

### 43755 CALLOW

pendant light; steel, wood, black, brown  
 Hängeleuchte; Stahl, Holz, schwarz, braun  
 luminaire en suspension; acier, bois, noir, marron

H 1100, Ø 230



E27



1x 40W



9 002759 437558





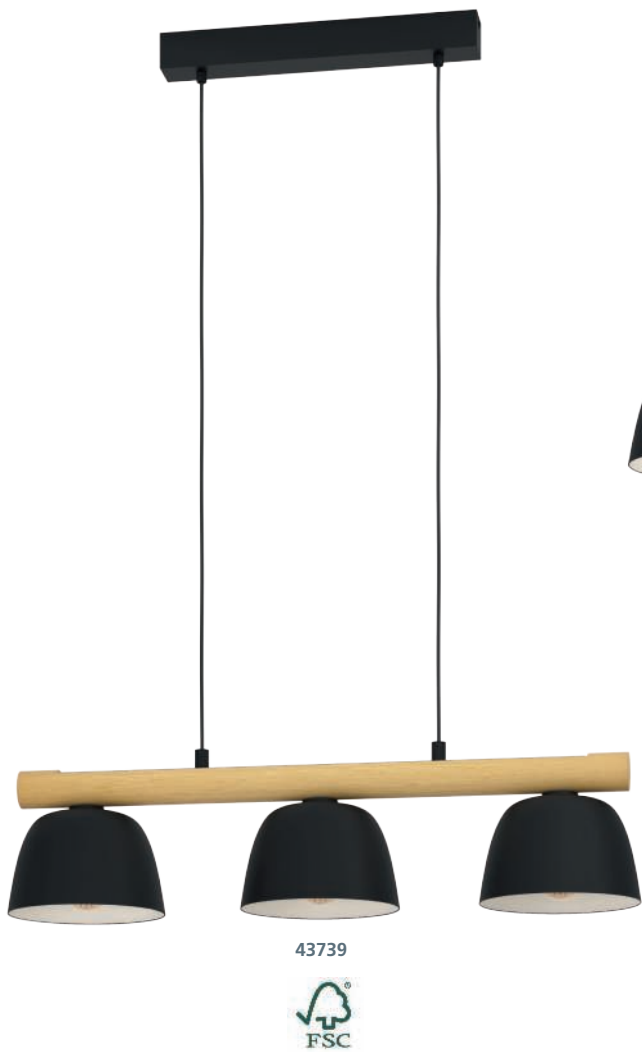

### 43739 SHERBURN

pendant light; steel, wood, black, brown  
 Hängeleuchte; Stahl, Holz, schwarz, braun  
 luminaire en suspension; acier, bois, noir, marron

L 770, B 200, H 1100



E27



3x 40W



9 002759 437398



### 43738 SHERBURN

ceiling light; steel, wood, black, brown  
 Deckenleuchte; Stahl, Holz, schwarz, braun  
 plafonnier; acier, bois, noir, marron

L 800, B 200, H 255



E27



3x 40W



9 002759 437381



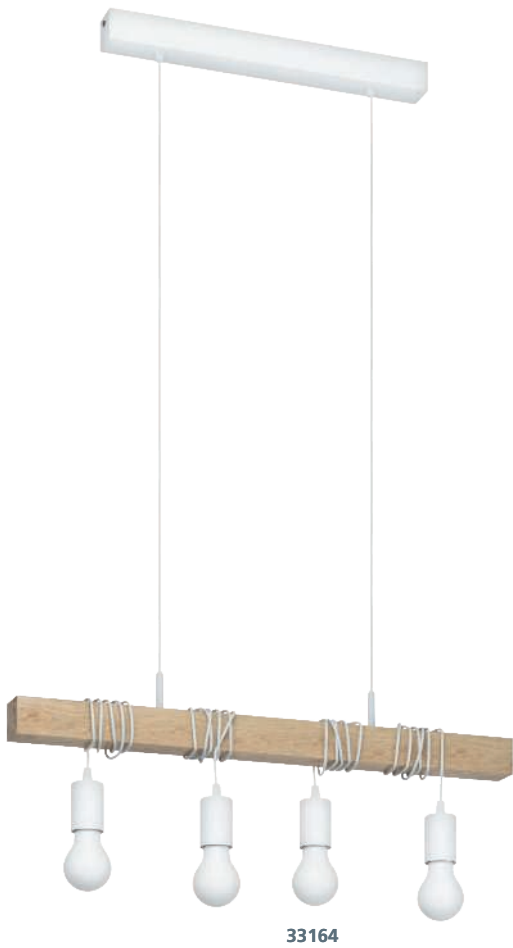

33164



33166



33165

### 33164 TOWNSHEND

pendant light; steel, white / wood, brown  
 Hängeleuchte; Stahl, weiss / Holz, braun  
 luminaire en suspension; acier, blanc / bois, marron

L 700, B 105, H 1100



E27 4x 60W



9 002759 331641

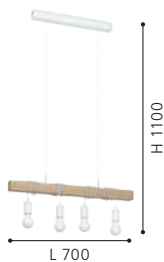

### 33165 TOWNSHEND

pendant light; steel, white / wood, brown  
 Hängeleuchte; Stahl, weiss / Holz, braun  
 luminaire en suspension; acier, blanc / bois, marron

L 1000, B 100, H 1100



E27 6x 60W



9 002759 331658

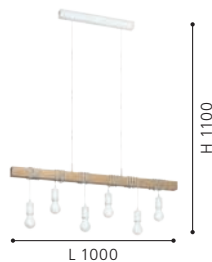

### 33166 TOWNSHEND

ceiling light; steel, white / wood, brown  
 Deckenleuchte; Stahl, weiss / Holz, braun  
 plafonnier; acier, blanc / bois, marron

L 550, B 105, H 265



E27 3x 60W



9 002759 331665

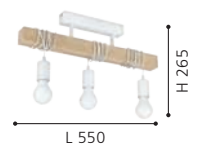



33162



33163



33167

### 33162 TOWNSHEND

wall light; steel, white / wood, brown  
Wandleuchte; Stahl, weiss / Holz, braun  
applique; acier, blanc / bois, marron

L 65, H 215, A 185



E27

1x 10W



9 002759 331627



### 33163 TOWNSHEND

table light; steel, white / wood, brown  
Tischleuchte; Stahl, weiss / Holz, braun  
luminaire de table; acier, blanc / bois, marron

L 175, B 155, H 500, Base: Ø 155



E27

1x 10W



9 002759 331634



### 33167 TOWNSHEND

floor light; steel, white / wood, brown  
Stehleuchte; Stahl, weiss / Holz, braun  
lampadaire; acier, blanc / bois, marron

L 205, B 250, H 1665, Base: Ø 250



E27

2x 10W



9 002759 331672





32916



32915

95499



#### DETAIL TOWNSHEND

Thanks to the long cable of the luminaire heads, the height can be adjusted individually.

Durch das lange Kabel der Leuchtenköpfe kann die Höhe individuell eingestellt werden.

Grâce au long câble des têtes de luminaire, la hauteur peut être réglée individuellement.

#### 32916 TOWNSHEND

pendant light; steel, wood, black, brown  
Hängeleuchte; Stahl, Holz, schwarz, braun  
luminaire en suspension; acier, bois, noir, marron

L 700, B 105, H 1100



E27 4x 60W



9 002759 329167

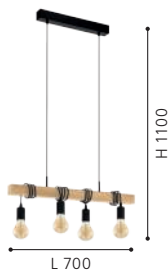

#### 95499 TOWNSHEND

pendant light; steel, wood, black, brown / wood, brown  
Hängeleuchte; Stahl, Holz, schwarz, braun / Holz, braun  
luminaire en suspension; acier, bois, noir, marron / bois, marron

L 1000, B 100, H 1100



E27 6x 60W



9 002759 954994



#### 32915 TOWNSHEND

ceiling light; steel, wood, black, brown  
Deckenleuchte; Stahl, Holz, schwarz, braun  
plafonnier; acier, bois, noir, marron

L 550, B 105, H 265



E27 3x 60W



9 002759 329150





32917



32918



32919

### 32917 TOWNSHEND

wall light; steel, wood, black, brown  
Wandleuchte; Stahl, Holz, schwarz, braun  
applique; acier, bois, noir, marron

L 65, H 215, A 190



E27



1x 10W



9 002759 329174



### 32918 TOWNSHEND

table light; steel, wood, black, brown  
Tischleuchte; Stahl, Holz, schwarz, braun  
luminaire de table; acier, bois, noir, marron

L 175, B 155, H 500, Base: Ø 155



E27



1x 10W



9 002759 329181



### 32919 TOWNSHEND

floor light; steel, wood, black, brown  
Stehleuchte; Stahl, Holz, schwarz, braun  
lampadaire; acier, bois, noir, marron

L 205, B 250, H 1665, Base: Ø 250



E27



2x 10W



9 002759 329198





43629



49755

### 43629 TOWNSHEND

pendant light; steel, wood, black, brown  
 Hängeleuchte; Stahl, Holz, schwarz, braun  
 luminaire en suspension; acier, bois, noir, marron

L 700, B 390, H 900



E27



5x 60W



9 002759 436292



### 49755 TOWNSHEND

pendant light; steel, black / wood, black  
 Hängeleuchte; Stahl, schwarz / Holz, schwarz  
 luminaire en suspension; acier, noir / bois, noir

L 1000, B 100, H 1100



E27



6x 60W



9 002759 497552

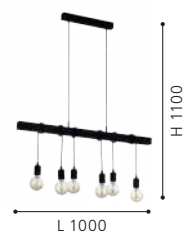



49744

43134

### 49744 TOWNSHEND

pendant light; wood, steel, brown, black  
 Hängeleuchte; Holz, Stahl, braun, schwarz  
 luminaire en suspension; bois, acier, marron, noir

L 1500, B 100, H 1100



E27



9x 60W



9 002759 497446

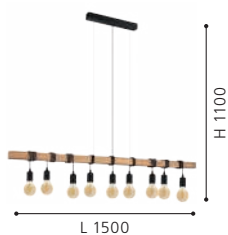

### 43134 TOWNSHEND 5

pendant light; steel, wood, black, brown  
 Hängeleuchte; Stahl, Holz, schwarz, braun  
 luminaire en suspension; acier, bois, noir, marron

L 1500, B 200, H 1100



E27



9x 60W



9 002759 431341

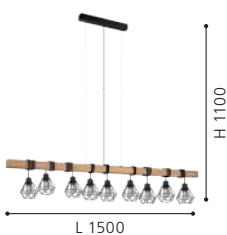



43131



43135



43132

### 43131 TOWNSHEND 5

ceiling light; steel, wood, black, brown  
Deckenleuchte; Stahl, Holz, schwarz, braun  
plafonnier; acier, bois, noir, marron

L 550, B 200, H 360



E27 3x 60W



9 002759 431310



### 43135 TOWNSHEND 5

wall light; steel, wood, black, brown  
Wandleuchte; Stahl, Holz, schwarz, braun  
applique; acier, bois, noir, marron

L 140, H 245, A 240



E27 1x 60W



9 002759 431358



### 43132 TOWNSHEND 5

pendant light; steel, wood, black, brown  
Hängeleuchte; Stahl, Holz, schwarz, braun  
luminaire en suspension; acier, bois, noir, marron

L 700, B 200, H 1100



E27 4x 60W



9 002759 431327







43133



43136

43137

### 43133 TOWNSHEND 5

pendant light; steel, wood, black, brown  
 Hängeleuchte; Stahl, Holz, schwarz, braun  
 luminaire en suspension; acier, bois, noir, marron

L 1000, B 200, H 1100



E27



6x 60W



9 002759 431334



### 43136 TOWNSHEND 5

table light; steel, wood, black, brown  
 Tischleuchte; Stahl, Holz, schwarz, braun  
 luminaire de table; acier, bois, noir, marron

L 220, B 155, H 500, Base: Ø 155



E27



1x 60W



9 002759 431365



### 43137 TOWNSHEND 5

floor light; steel, wood, black, brown  
 Stehleuchte; Stahl, Holz, schwarz, braun  
 lampadaire; acier, bois, noir, marron

L 400, B 250, H 1665, Base: Ø 250



E27



2x 60W



9 002759 431372





43378



43379

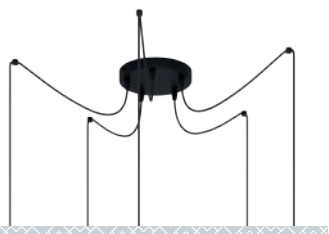

**DETAIL 43379**

The luminaire heads can be installed on the ceiling individually.  
 Die Leuchtenköpfe können individuell an die Decke montiert werden.  
 Les têtes de luminaires peuvent être montées individuellement au plafond.

**43378 PALMORLA**

pendant light; steel, wood, black, brown  
 Hängeleuchte; Stahl, Holz, schwarz, braun  
 luminaire en suspension; acier, bois, noir, marron

L 760, B 160, H 1100



E27 3x 60W



9 002759 433789



L 760

H 1100

**43379 PALMORLA**

pendant light; steel, wood, black, brown  
 Hängeleuchte; Stahl, Holz, schwarz, braun  
 luminaire en suspension; acier, bois, noir, marron

H 1300, Ø 845



E27 5x 60W



9 002759 433796

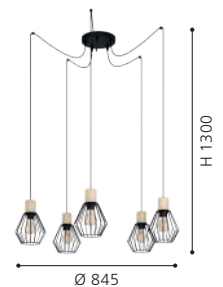

Ø 845

H 1300



43581



43582

### 43581 DISTAFF

pendant light; steel, black  
Hängeleuchte; Stahl, schwarz  
luminaire en suspension; acier, noir

L 900, B 185, H 1100



E27



3x 40W



9 002759 435813



### 43582 DISTAFF

pendant light; steel, black  
Hängeleuchte; Stahl, schwarz  
luminaire en suspension; acier, noir

H 1300, Ø 340



E27



3x 40W



9 002759 435820





49997



49878

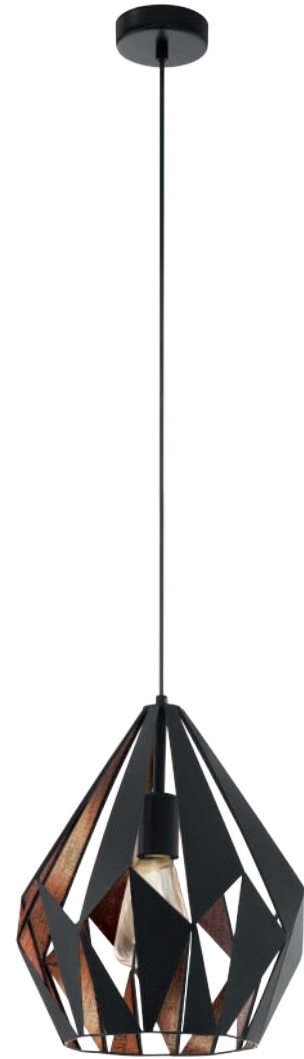

49254

### 49997 CARLTON 1

pendant light; steel, black, copper  
Hängeleuchte; Stahl, schwarz, kupfer  
luminaire en suspension; acier, noir, cuivre

H 1100, Ø 205



E27 1x 60W



9 002759 499976

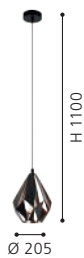

### 49878 CARLTON 1

pendant light; steel, black, copper  
Hängeleuchte; Stahl, schwarz, kupfer  
luminaire en suspension; acier, noir, cuivre

H 1500, Ø 385



E27 1x 60W



9 002759 498788



### 49254 CARLTON 1

pendant light; steel, black, copper  
Hängeleuchte; Stahl, schwarz, kupfer  
luminaire en suspension; acier, noir, cuivre

H 1100, Ø 310



E27 1x 60W



9 002759 492540





49991



49992



49994

### 49991 CARLTON 1

pendant light; steel, black, copper  
Hängeleuchte; Stahl, schwarz, kupfer  
luminaire en suspension; acier, noir, cuivre

L 805, B 205, H 1100



E27



3x 60W



9 002759 499914



L 805

H 1100

### 49992 CARLTON 1

wall light; steel, black, copper  
Wandleuchte; Stahl, schwarz, kupfer  
applique; acier, noir, cuivre

L 205, H 330, A 220



E27



1x 60W



9 002759 499921



L 205

H 330

A 220

### 49994 CARLTON 1

floor light; steel, black, copper  
Stehleuchte; Stahl, schwarz, kupfer  
lampadaire; acier, noir, cuivre

H 1525, Ø 255, Base: Ø 230



E27



1x 60W



9 002759 499945



Ø 255

H 1525

Ø 230



43846



43716

### 43846 CARLTON 1

pendant light; steel, black, copper  
Hängeleuchte; Stahl, schwarz, kupfer  
luminaire en suspension; acier, noir, cuivre

L 1455, B 385, H 1070



E27



6x 40W



9 002759 438463



L 1455

### 43716 CARLTON 7

spot; steel, black, copper color-antique  
Spot; Stahl, schwarz, kupferfarben-antik  
spot; acier, noir, aspect cuivre-antique

L 420, B 160, H 255



E27



2x 40W



9 002759 437169



L 420



43717



43718



43715

### 43717 CARLTON 7

spot; steel, black, copper color-antique  
Spot; Stahl, schwarz, kupferfarben-antik  
spot; acier, noir, aspect cuivre-antique

L 730, B 160, H 255



E27



3x 40W



9 002759 437176



### 43715 CARLTON 7

spot; steel, black, copper color-antique  
Spot; Stahl, schwarz, kupferfarben-antik  
spot; acier, noir, aspect cuivre-antique

Ø 160, A 255



E27



1x 40W



9 002759 437152

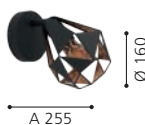

### 43718 CARLTON 7

spot; steel, black, copper color-antique  
Spot; Stahl, schwarz, kupferfarben-antik  
spot; acier, noir, aspect cuivre-antique

L 370, B 370, H 255



E27



4x 40W



9 002759 437183





43057



43399



43058

#### 43057 CARLTON 4

wall light; steel, black, copper color-antique  
Wandleuchte; Stahl, schwarz, kupferfarben-antik  
applique; acier, noir, aspect cuivre-antique

L 160, H 315, A 225



E27 1x 60W



9 002759 430573



#### 43058 CARLTON 4

table light; steel, black, copper color-antique  
Tischleuchte; Stahl, schwarz, kupferfarben-antik  
luminaire de table; acier, noir, aspect cuivre-antique

L 220, B 160, H 505, Base: Ø 170

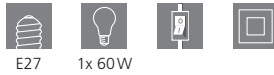

E27 1x 60W



9 002759 430580

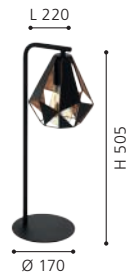

#### 43399 CARLTON 6

ceiling light; steel, black, copper  
Deckenleuchte; Stahl, schwarz, kupfer  
plafonnier; acier, noir, cuivre

H 235, Ø 470



E27 1x 60W



9 002759 433994

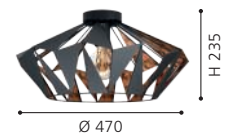





43077

### 43077 CARLTON 5

table light; steel, black, copper / fabric, black, copper  
Tischleuchte; Stahl, schwarz, kupfer / Textil, schwarz, kupfer  
luminaire de table; acier, noir, cuivre / tissu, noir, cuivre

H 510, Ø 250



E27



1x 60W



9 002759 430771



### 49932 CARLTON 1

pendant light; steel, white, honey gold  
 Hängeleuchte; Stahl, weiss, honiggold  
 luminaire en suspension; acier, blanc, or

H 1100, Ø 310



### 43002 CARLTON 1

pendant light; steel, white, gold  
 Hängeleuchte; Stahl, weiss, gold  
 luminaire en suspension; acier, blanc, or

L 805, B 205, H 1100

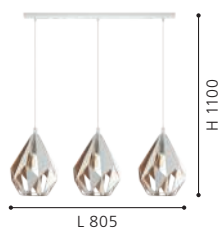

### 43078 CARLTON 5

table light; steel, white, honey gold / fabric, white  
 Tischleuchte; Stahl, weiss, honiggold / Textil, weiss  
 luminaire de table; acier, blanc, or / tissu, blanc

H 510, Ø 250

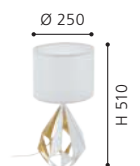



43001

### 43001 CARLTON 1

pendant light; steel, white, gold  
Hängeleuchte; Stahl, weiss, gold  
luminaire en suspension; acier, blanc, or

H 1100, Ø 205



E27



1x 60W



9 002759 430016





49255



49931



49026

### 49255 CARLTON 1

pendant light; steel, black, silver  
Hängeleuchte; Stahl, schwarz, silber  
luminaire en suspension; acier, noir, argent

H 1100, Ø 310



E27 1x 60W



9 002759 492557



### 49931 CARLTON 1

pendant light; steel, black, gold  
Hängeleuchte; Stahl, schwarz, gold  
luminaire en suspension; acier, noir, or

H 1100, Ø 310



E27 1x 60W



9 002759 499310



### 49026 CARLTON-P

pendant light; steel, pastel light green  
Hängeleuchte; Stahl, Pastell hellgrün  
luminaire en suspension; acier, pastel vert clair

H 1500, Ø 310



E27 1x 60W



9 002759 490263





49024

### 49024 CARLTON-P

pendant light; steel, pastel apricot  
Hängeleuchte; Stahl, Pastell apricot  
luminaire en suspension; acier, Pastel abricot

H 1500, Ø 310



E27



1x 60W



9 1002759 490249





43815



43814



### 43815 CARLTON

pendant light; steel, gold-coloured  
Hängeleuchte; Stahl, goldfarben  
luminaire en suspension; acier, or

H 1100, Ø 385



E27



1x 60W



9 002759 438159



### 43814 CARLTON

pendant light; steel, gold-coloured  
Hängeleuchte; Stahl, goldfarben  
luminaire en suspension; acier, or

H 1100, Ø 310



E27



1x 60W



9 002759 438142





49257



49258



49259

### 49257 CARLTON

pendant light; steel, black  
Hängeleuchte; Stahl, schwarz  
luminaire en suspension; acier, noir

H 1100, Ø 310



E27 1x 60W



9 002759 492571

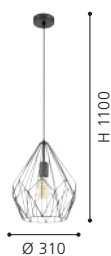

### 49258 CARLTON

pendant light; steel, copper-coloured  
Hängeleuchte; Stahl, kupferfarben  
luminaire en suspension; acier, cuivré

H 1100, Ø 310



E27 1x 60W



9 002759 492588



### 49259 CARLTON

pendant light; steel, mint  
Hängeleuchte; Stahl, mint  
luminaire en suspension; acier, menthe

H 1100, Ø 310



E27 1x 60W



9 002759 492595







49933



49935

### 49933 CARLTON

pendant light; steel, gold-coloured  
Hängeleuchte; Stahl, goldfarben  
luminaire en suspension; acier, or

H 1100, Ø 310



E27



1x 60W



9 002759 499334

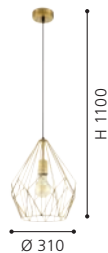

### 49935 CARLTON

pendant light; steel, silver  
Hängeleuchte; Stahl, silber  
luminaire en suspension; acier, argent

H 1100, Ø 310



E27



1x 60W



9 002759 499358





43695

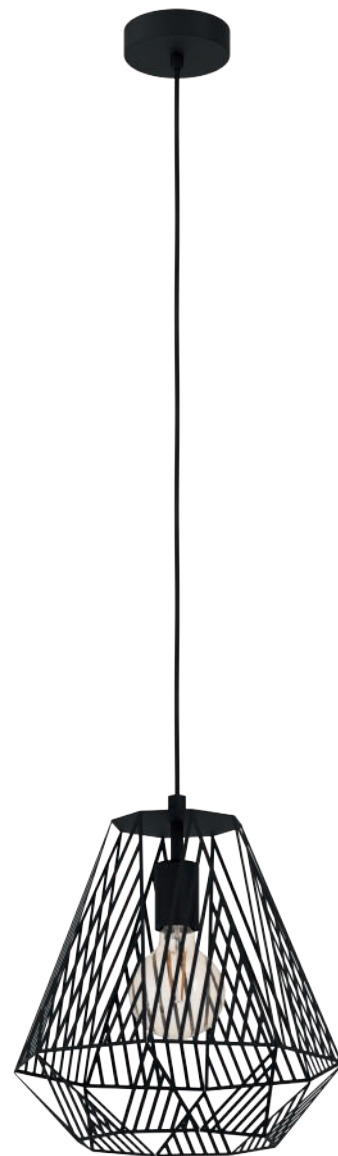

43692

### 43695 STYPE

pendant light; steel, gold-coloured  
 Hängeleuchte; Stahl, goldfarben  
 luminaire en suspension; acier, or

H 1100, Ø 330



E27 1x 40W



9 002759 436957



### 43692 STYPE

pendant light; steel, black  
 Hängeleuchte; Stahl, schwarz  
 luminaire en suspension; acier, noir

H 1100, Ø 330



E27 1x 40W



9 002759 436926





43696



43693

### 43696 STYPE

pendant light; steel, gold-coloured  
Hängeleuchte; Stahl, goldfarben  
luminaire en suspension; acier, or

L 960, B 200, H 1100



E27



3x 40W



9 002759 436964



### 43693 STYPE

pendant light; steel, black  
Hängeleuchte; Stahl, schwarz  
luminaire en suspension; acier, noir

L 960, B 200, H 1100



E27



3x 40W



9 002759 436933





43359



43361

### 43359 STRAITON

pendant light; steel, black  
Hängeleuchte; Stahl, schwarz  
luminaire en suspension; acier, noir

H 1100, Ø 515



E27 1x 60W



9 002759 433598

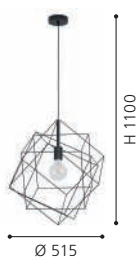

### 43361 STRAITON

pendant light; steel, black  
Hängeleuchte; Stahl, schwarz  
luminaire en suspension; acier, noir

L 905, B 240, H 1100



E27 3x 60W



9 002759 433611



### 43366 STRAITON

pendant light; steel, black  
Hängeleuchte; Stahl, schwarz  
luminaire en suspension; acier, noir

H 1100, Ø 645



E27 3x 60W



9 002759 433666

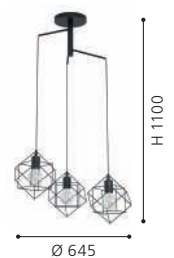



43366



43358

### 43358 STRAITON

pendant light; steel, black  
 Hängeleuchte; Stahl, schwarz  
 luminaire en suspension; acier, noir

L 240, B 205, H 1100



E27



1x 60W



9 002759 433581

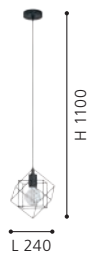



43481



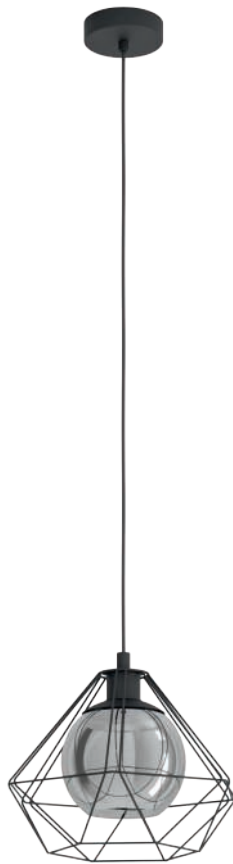

43482



43483

### 43481 VERNHAM

pendant light; steel, black / glass vaporized, black-transparent  
 Hängeleuchte; Stahl, schwarz / Glas bedampft, schwarz-transparent  
 luminaire en suspension; acier, noir / verre vaporisé, noir transparent

H 1100, Ø 445



E27



1x 40W



9 002759 434816

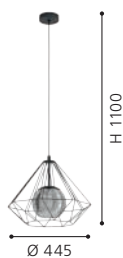

### 43482 VERNHAM

pendant light; steel, black / glass vaporized, black-transparent  
 Hängeleuchte; Stahl, schwarz / Glas bedampft, schwarz-transparent  
 luminaire en suspension; acier, noir / verre vaporisé, noir transparent

H 1100, Ø 325



E27



1x 40W



9 002759 434823

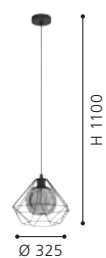

### 43483 VERNHAM

pendant light; steel, black / glass vaporized, black-transparent  
 Hängeleuchte; Stahl, schwarz / Glas bedampft, schwarz-transparent  
 luminaire en suspension; acier, noir / verre vaporisé, noir transparent

L 1145, B 325, H 1100



E27



3x 40W



9 002759 434830

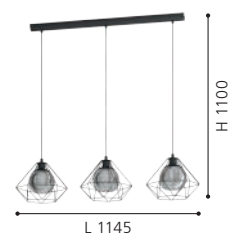



43004



49081

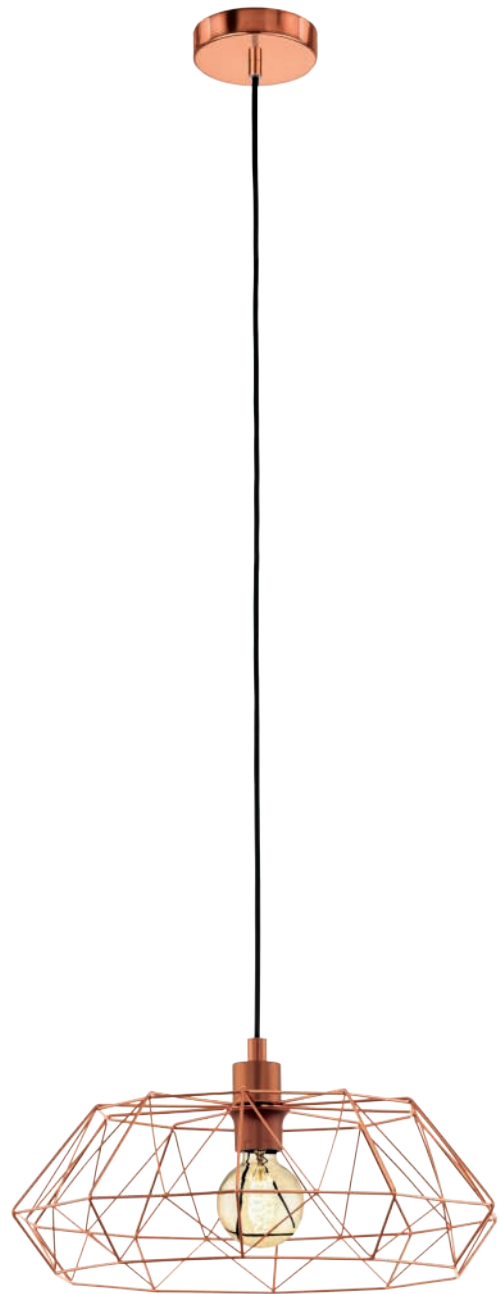

49488

### 43004 TARBES

ceiling light; steel, black  
Deckenleuchte; Stahl, schwarz  
plafonnier; acier, noir

H 275, Ø 325



E27 1x 60W



9 002759 430047

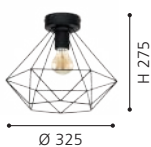

### 49081 TARBES

wall light; steel, black  
Wandleuchte; Stahl, schwarz  
applique; acier, noir

L 155, H 375, A 275



E27 1x 60W



9 002759 490812



### 49488 CARLTON 2

pendant light; steel, copper  
Hängeleuchte; Stahl, kupfer  
luminaire en suspension; acier, cuivre

H 1100, Ø 455



E27 1x 60W



9 002759 494889

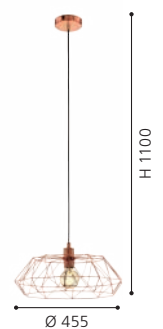





49487

### 49487 CARLTON 2

pendant light; steel, black  
Hängeleuchte; Stahl, schwarz  
luminaire en suspension; acier, noir

H 1100, Ø 455



E27



1x 60W



9 002759 494872

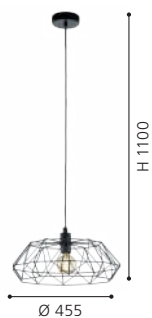



43766



43767

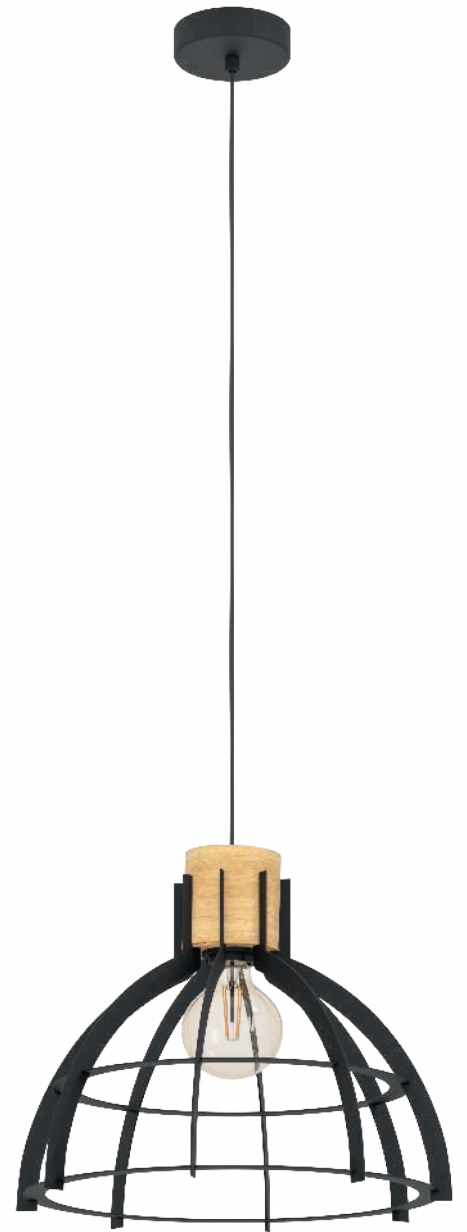

43769

### 43766 STILLINGTON

ceiling light; steel, black, gold  
Deckenleuchte; Stahl, schwarz, gold  
plafonnier; acier, noir, or

H 315, Ø 415



E27 1x 40W



9 002759 437664



### 43767 STILLINGTON

pendant light; steel, black, gold  
Hängeleuchte; Stahl, schwarz, gold  
luminaire en suspension; acier, noir, or

H 1100, Ø 415



E27 1x 40W



9 002759 437671



### 43769 STILLINGTON

pendant light; steel, wood, black, brown  
Hängeleuchte; Stahl, Holz, schwarz, braun  
luminaire en suspension; acier, bois, noir, marron

H 1100, Ø 415



E27 1x 40W



9 002759 437695





43768

### 43768 STILLINGTON

ceiling light; steel, wood, black, brown  
Deckenleuchte; Stahl, Holz, schwarz, braun  
plafonnier; acier, bois, noir, marron

H 315, Ø 415



E27



1x 40W



9 002759 437688





43813

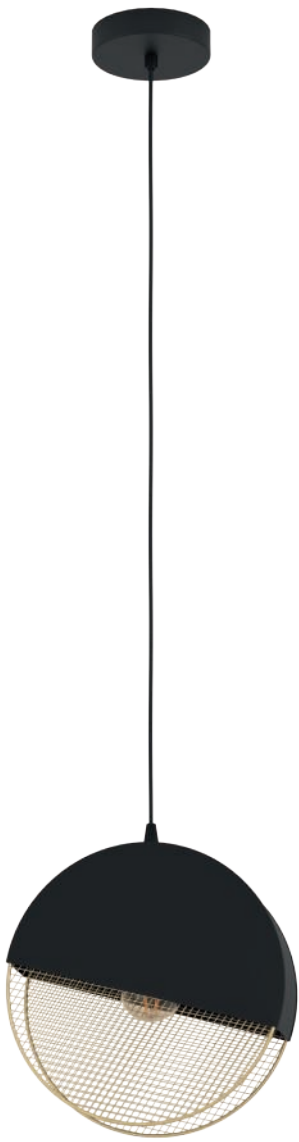

43811



43812

### 43813 MUMBLES

table light; steel, black, gold  
Tischleuchte; Stahl, schwarz, gold  
luminaire de table; acier, noir, or

L 280, B 90, H 285, Base: Ø 170



E27 1x 40W



9 002759 438135



### 43811 MUMBLES

pendant light; steel, black, gold  
Hängeleuchte; Stahl, schwarz, gold  
luminaire en suspension; acier, noir, or

L 285, B 90, H 1100



E27 1x 40W



9 002759 438111

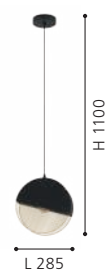

### 43812 MUMBLES

pendant light; steel, black, gold  
Hängeleuchte; Stahl, schwarz, gold  
luminaire en suspension; acier, noir, or

L 860, B 90, H 1100



E27 2x 40W



9 002759 438128

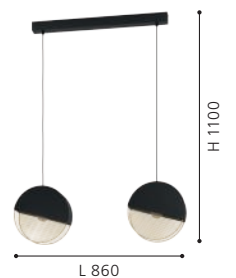

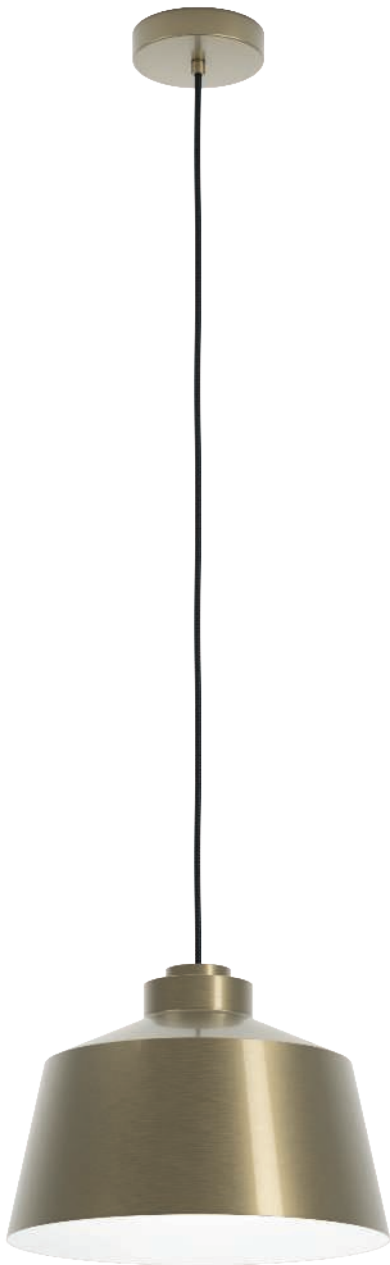

43816



43818



43817

### 43816 SOUTHERY

pendant light; steel, creme-gold brushed, white  
Hängeleuchte; Stahl, creme-gold gebürstet, weiss  
luminaire en suspension; acier, or crème brossé, blanc

H 1100, Ø 350



E27 1x 40W



9 002759 438166

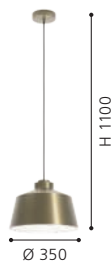

### 43817 SOUTHERY

spot; steel, creme-gold brushed, white  
Spot; Stahl, creme-gold gebürstet, weiss  
spot; acier, or crème brossé, blanc

L 185, B 110, H 210



E27 1x 40W



9 002759 438173



### 43818 SOUTHERY

spot; steel, creme-gold brushed, white  
Spot; Stahl, creme-gold gebürstet, weiss  
spot; acier, or crème brossé, blanc

L 470, B 110, H 210



E27 2x 40W



9 002759 438180





43819

### 43819 SOUTHERY

spot; steel, creme-gold brushed, white  
Spot; Stahl, creme-gold gebürstet, weiss  
spot; acier, or crème brossé, blanc

L 700, B 110, H 210



E27



3x 40W



9 002759 438197





43443



#### DETAIL 43599

This ceiling luminaire has a great play of light.

Diese Deckenleuchte verfügt über ein tolles Lichtspiel.

Ce plafonnier a un grand jeu de lumière.

#### 43443 CASTANUELO

wall / ceiling light; steel, gold-coloured  
Wand- / Deckenleuchte; Stahl, goldfarben  
applique / plafonnier; acier, or

H 105, Ø 425



E27



1x 40W



9 002759 434434

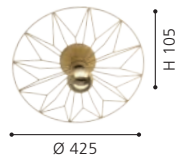





43599



43808



43809

### 43599 CASTANUELO

wall / ceiling light; steel, gold-coloured  
Wand- / Deckenleuchte; Stahl, goldfarben  
applique / plafonnier; acier, or

H 100, Ø 425



E27



1x 40W



9 002759 435998



### 43808 CASTANUELO

table light; steel, black, gold  
Tischleuchte; Stahl, schwarz, gold  
luminaire de table; acier, noir, or

L 370, B 270, H 575, Base: Ø 295



E27



1x 40W



9 002759 438081



### 43809 CASTANUELO

floor light; steel, black, gold  
Stehleuchte; Stahl, schwarz, gold  
lampadaire; acier, noir, or

L 500, B 270, H 1520, Base: Ø 745



E27



1x 40W



9 002759 438098

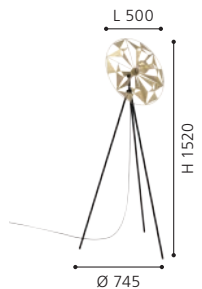
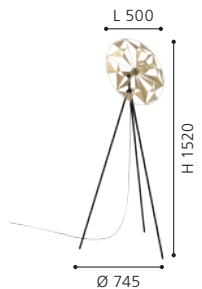



43679



43681

### 43679 TARDES

pendant light; steel, brushed brass  
 Hängeleuchte; Stahl, messing-gebürstet  
 luminaire en suspension; acier, laiton brossé

H 1100, Ø 325



E27



1x 60W



9 002759 436797



### 43681 TARDES

pendant light; steel, brushed brass  
 Hängeleuchte; Stahl, messing-gebürstet  
 luminaire en suspension; acier, laiton brossé

H 1300, Ø 175



E27



1x 60W



9 002759 436810





43682



43683

### 43682 TARBES

pendant light; steel, brushed brass  
 Hängeleuchte; Stahl, messing-gebürstet  
 luminaire en suspension; acier, laiton brossé

L 795, B 175, H 1300



E27



3x 60W



9 002759 436827



### 43683 TARBES

pendant light; steel, brushed brass  
 Hängeleuchte; Stahl, messing-gebürstet  
 luminaire en suspension; acier, laiton brossé

H 1300, Ø 355



E27



3x 60W



9 002759 436834





43654



43655

### 43654 TARBES 2

ceiling light; steel, black, brass  
Deckenleuchte; Stahl, schwarz, messing  
plafonnier; acier, noir, laiton

H 245, Ø 450



E27



3x 40W



9 002759 436544



Ø 450

H 245

### 43655 TARBES 2

ceiling light; steel, black, brass  
Deckenleuchte; Stahl, schwarz, messing  
plafonnier; acier, noir, laiton

L 770, B 175, H 245



E27



3x 40W



9 002759 436551



L 770

H 245



43678



43684

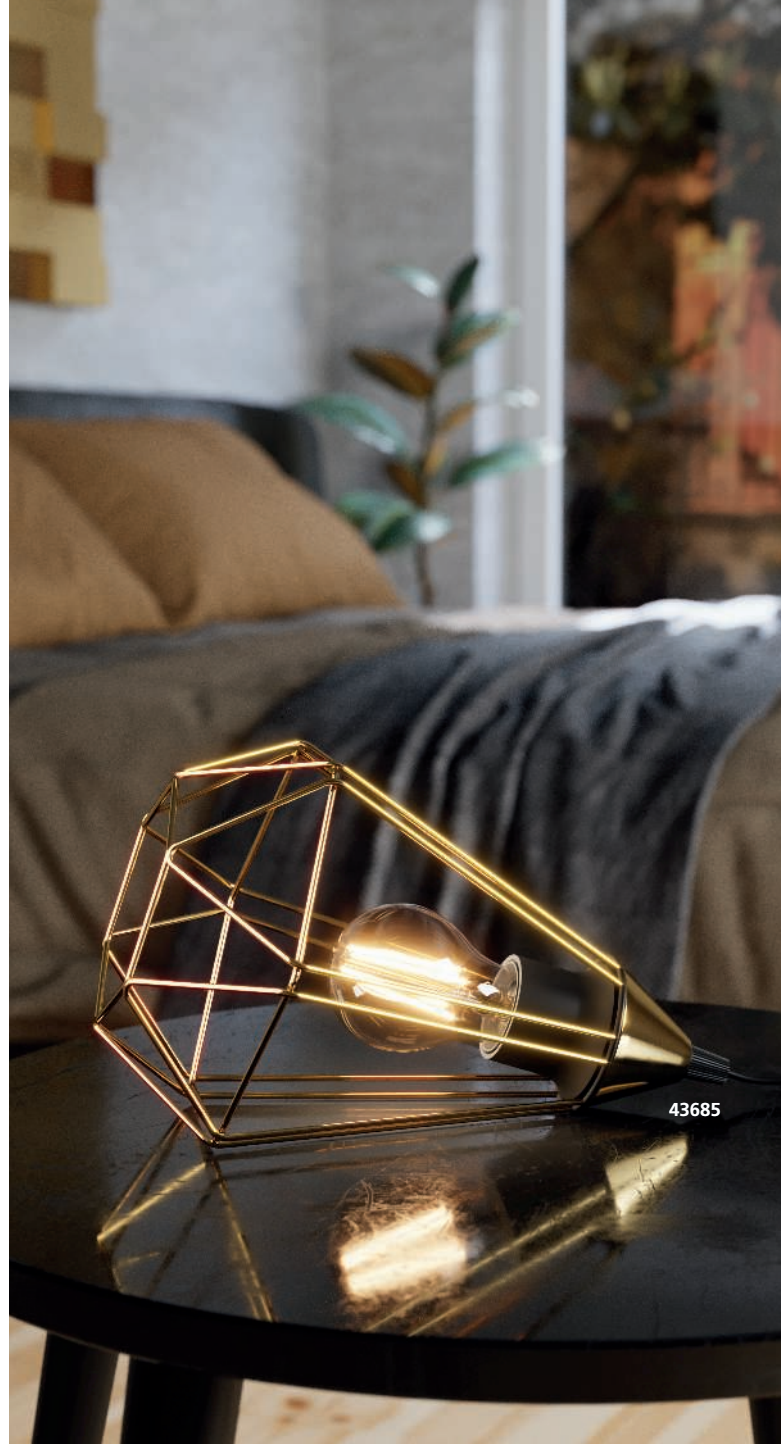

43685

### 43678 TARDES

ceiling light; steel, brushed brass  
Deckenleuchte; Stahl, messing-gebürstet  
plafonnier; acier, laiton brossé

H 275, Ø 325



E27



1x 60W



9 002759 436780

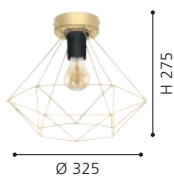

### 43684 TARDES

wall light; steel, brushed brass  
Wandleuchte; Stahl, messing-gebürstet  
applique; acier, laiton brossé

L 155, H 345, A 275



E27



1x 60W



9 002759 436841



### 43685 TARDES

table light; steel, brushed brass  
Tischleuchte; Stahl, messing-gebürstet  
luminaire de table; acier, laiton brossé

H 265, Ø 175



E27



1x 60W



9 002759 436858

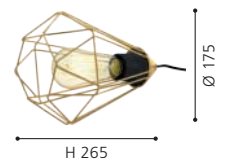



94187



94188



94191

### 94187 TARBES

pendant light; plastic, black / steel, black  
 Hängeleuchte; Kunststoff, schwarz / Stahl, schwarz  
 luminaire en suspension; plastique, noir / acier, noir

H 1100, Ø 175



E27 1x 60W



9 002759 941871



### 94188 TARBES

pendant light; plastic, black / steel, black  
 Hängeleuchte; Kunststoff, schwarz / Stahl, schwarz  
 luminaire en suspension; plastique, noir / acier, noir

H 1100, Ø 325



E27 1x 60W



9 002759 941888



### 94191 TARBES

pendant light; steel, black / steel, black  
 Hängeleuchte; Stahl, schwarz / Stahl, schwarz  
 luminaire en suspension; acier, noir / acier, noir

H 1100, Ø 310



E27 3x 60W



9 002759 941918

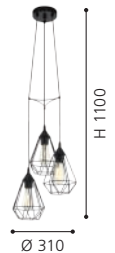

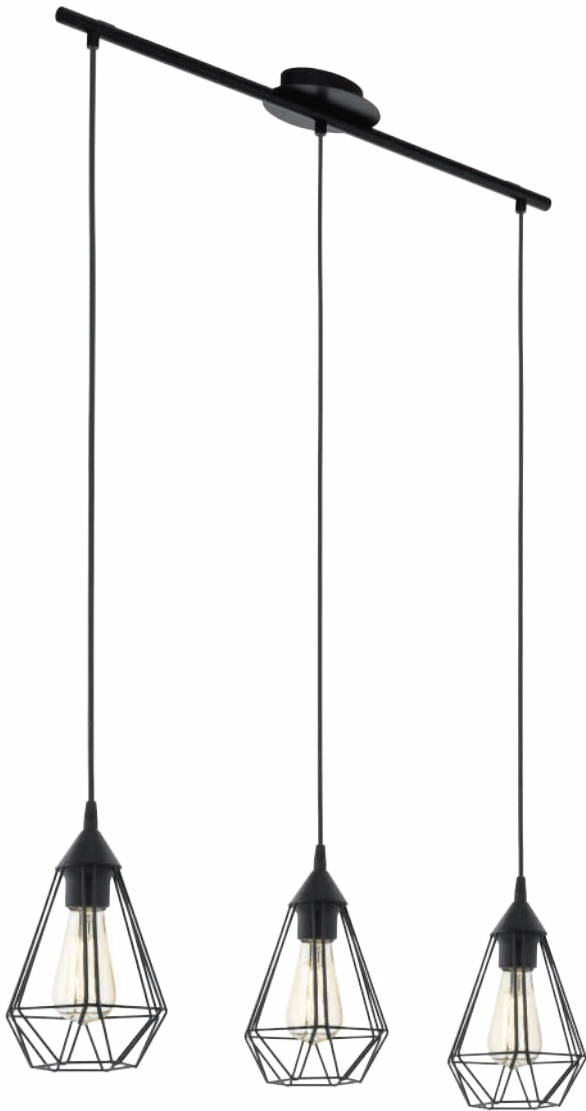

94189



94192

### 94189 TARBES

pendant light; steel, black / steel, black  
 Hängeleuchte; Stahl, schwarz / Stahl, schwarz  
 luminaire en suspension; acier, noir / acier, noir

L 790, B 175, H 1100



E27



3x 60W



9 002759 941895



### 94192 TARBES

table light; steel, black / steel, black  
 Tischleuchte; Stahl, schwarz / Stahl, schwarz  
 luminaire de table; acier, noir / acier, noir

H 265, Ø 175



E27



1x 60W



9 002759 941925

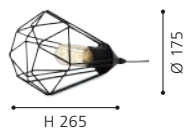

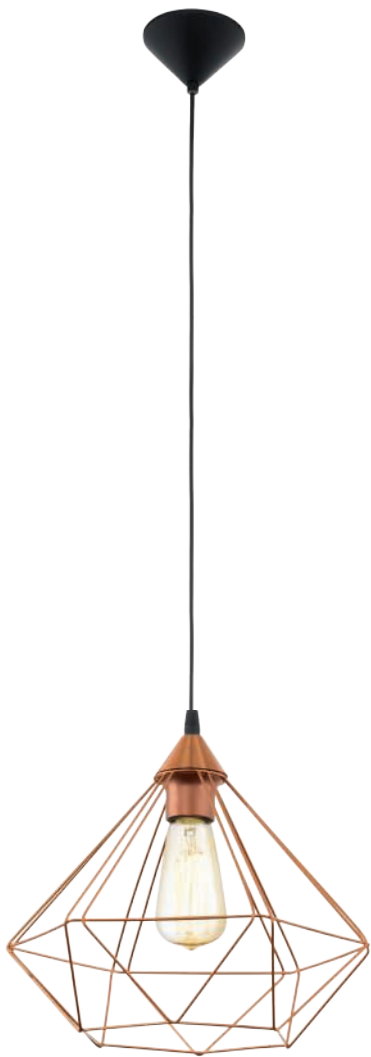

94194



94195

### 94194 TARDES

pendant light; plastic, black / steel, copper-coloured  
 Hängeleuchte; Kunststoff, schwarz / Stahl, kupferfarben  
 luminaire en suspension; plastique, noir / acier, cuivré

H 1100, Ø 325



E27 1x 60W



9 002759 941949

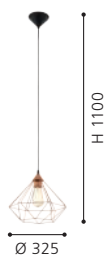

### 94195 TARDES

pendant light; steel, black / steel, copper-coloured  
 Hängeleuchte; Stahl, schwarz / Stahl, kupferfarben  
 luminaire en suspension; acier, noir / acier, cuivré

L 790, B 175, H 1100



E27 3x 60W



9 002759 941956

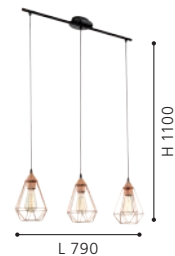





94196



94197



94193

### 94196 TARDES

pendant light; steel, black / steel, copper-coloured  
Hängeleuchte; Stahl, schwarz / Stahl, kupferfarben  
luminaire en suspension; acier, noir / acier, cuivré

H 1100, Ø 310



E27



3x 60W



9 002759 941963

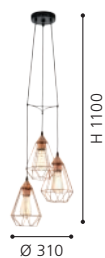

### 94197 TARDES

table light; steel, black / steel, copper-coloured  
Tischleuchte; Stahl, schwarz / Stahl, kupferfarben  
luminaire de table; acier, noir / acier, cuivré

H 265, Ø 175



E27



1x 60W



9 002759 941970

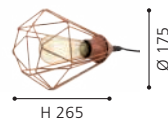

### 94193 TARDES

pendant light; plastic, black / steel, copper-coloured  
Hängeleuchte; Kunststoff, schwarz / Stahl, kupferfarben  
luminaire en suspension; plastique, noir / acier, cuivré

H 1100, Ø 175



E27



1x 60W



9 002759 941932





49643

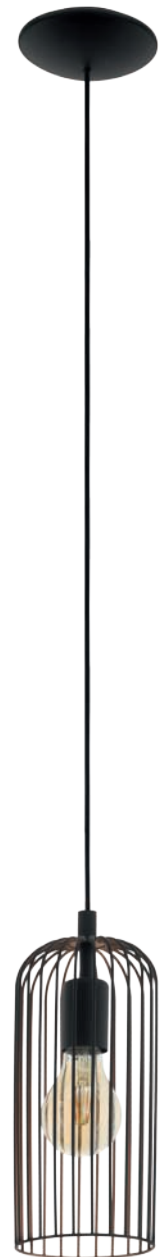

49644



**DETAIL 49643**

The luminaire heads can be installed on the ceiling individually.

Die Leuchtenköpfe können individuell an die Decke montiert werden.

Les têtes de luminaires peuvent être montées individuellement au plafond.

**49643 ROCCAMENA**

pendant light; steel, black, copper  
 Hängeleuchte; Stahl, schwarz, kupfer  
 luminaire en suspension; acier, noir, cuivre

B 130, H 1300



E27



6x 60W



9 002759 496432



**49644 ROCCAMENA**

pendant light; steel, black, copper  
 Hängeleuchte; Stahl, schwarz, kupfer  
 luminaire en suspension; acier, noir, cuivre

H 1100, Ø 130



E27



1x 60W



9 002759 496449

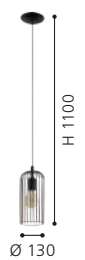



49645



49646

### 49646 ROCCAMENA

table light; steel, black, copper  
Tischleuchte; Stahl, schwarz, kupfer  
luminaire de table; acier, noir, cuivre

H 310, Ø 130, Base: Ø 130



E27



1x 60W



9 002759 496463



### 49645 ROCCAMENA

pendant light; steel, black, copper  
Hängeleuchte; Stahl, schwarz, kupfer  
luminaire en suspension; acier, noir, cuivre

L 730, B 130, H 1100



E27



3x 60W



9 002759 496456



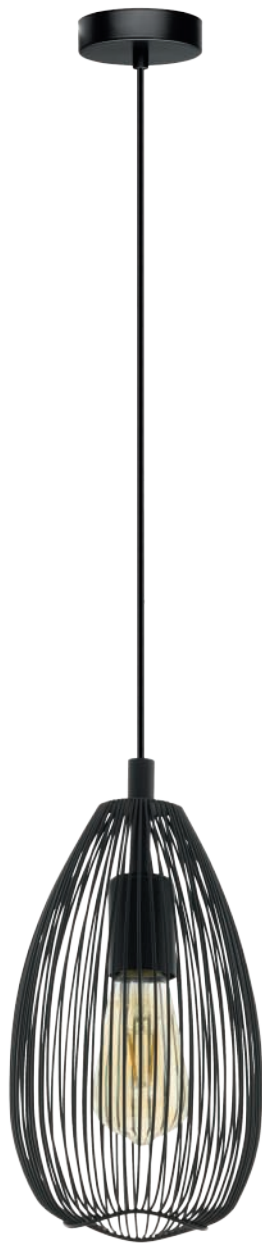

49141



49143

### 49141 CLEVEDON

pendant light; steel, black  
Hängeleuchte; Stahl, schwarz  
luminaire en suspension; acier, noir

H 1100, Ø 240



E27 1x 60W



9 002759 491413



### 49143 CLEVEDON

wall light; steel, black  
Wandleuchte; Stahl, schwarz  
applique; acier, noir

L 170, H 350, A 200



E27 1x 60W



9 002759 491437



### 49142 CLEVEDON

pendant light; steel, black  
Hängeleuchte; Stahl, schwarz  
luminaire en suspension; acier, noir

L 780, B 170, H 1100



E27 3x 60W



9 002759 491420





49142



49472



49477

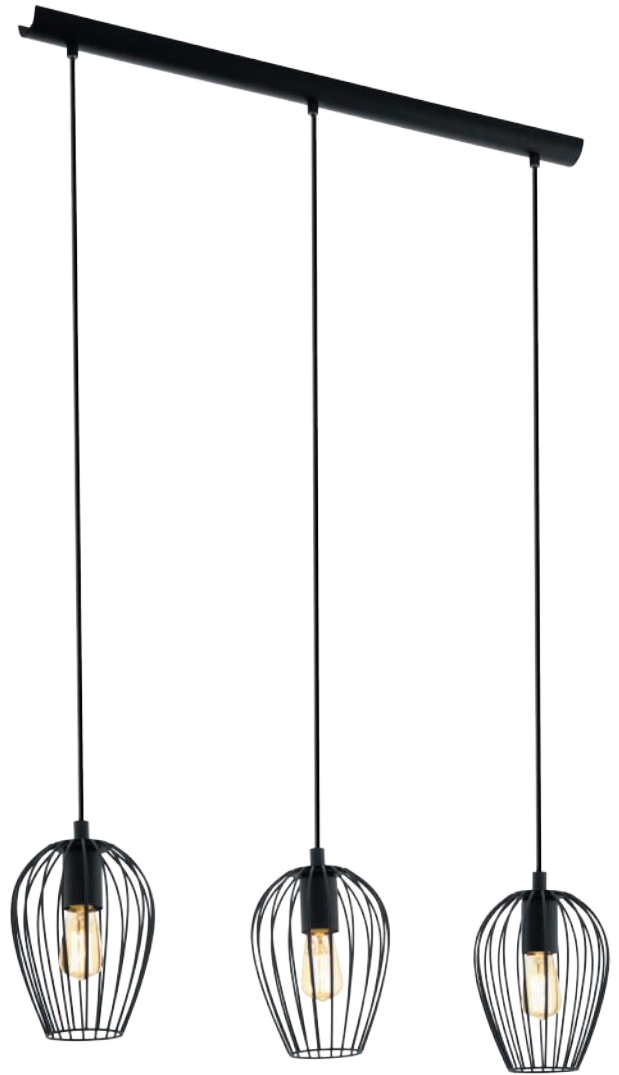

49478

### 49472 NEWTOWN

pendant light; steel, black  
Hängeleuchte; Stahl, schwarz  
luminaire en suspension; acier, noir

H 1100, Ø 275



E27



1x 60W



9 002759 494728



### 49477 NEWTOWN

pendant light; steel, black  
Hängeleuchte; Stahl, schwarz  
luminaire en suspension; acier, noir

H 1100, Ø 160



E27



1x 60W



9 002759 494773

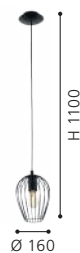

### 49478 NEWTOWN

pendant light; steel, black  
Hängeleuchte; Stahl, schwarz  
luminaire en suspension; acier, noir

L 700, B 160, H 1100



E27



3x 60W



9 002759 494780





49479



49481



49474

### 49479 NEWTOWN

pendant light; steel, black  
Hängeleuchte; Stahl, schwarz  
luminaire en suspension; acier, noir

H 1300, Ø 380



E27 3x 60W



9 002759 494797



### 49481 NEWTOWN

table light; steel, black  
Tischleuchte; Stahl, schwarz  
luminaire de table; acier, noir

H 230, Ø 160, Base: Ø 120



E27 1x 60W



9 002759 494810



### 49474 NEWTOWN

floor light; steel, black  
Stehleuchte; Stahl, schwarz  
lampadaire; acier, noir

H 1595, Ø 275, Base: Ø 230

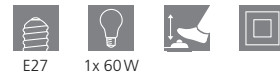

E27 1x 60W



9 002759 494742





49447

49448

### 49447 AUSTELL

pendant light; steel, black / steel, fabric, black, gold  
 Hängeleuchte; Stahl, schwarz / Stahl, Textil, schwarz, gold  
 luminaire en suspension; acier, noir / acier, tissu, noir, or

H 1100, Ø 165



E27 1x 60W



9 002759 494476



### 49448 AUSTELL

pendant light; steel, black / steel, fabric, black, gold  
 Hängeleuchte; Stahl, schwarz / Stahl, Textil, schwarz, gold  
 luminaire en suspension; acier, noir / acier, tissu, noir, or

L 765, B 165, H 1100



E27 3x 60W



9 002759 494483







49446



49509

### 49446 AUSTELL

pendant light; steel, black / steel, fabric, black, gold  
 Hängeleuchte; Stahl, schwarz / Stahl, Textil, schwarz, gold  
 luminaire en suspension; acier, noir / acier, tissu, noir, or

H 1100, Ø 360



E27



1x 60W



9 002759 494469



### 49509 AUSTELL

pendant light; steel, black / steel, fabric, black, gold  
 Hängeleuchte; Stahl, schwarz / Stahl, Textil, schwarz, gold  
 luminaire en suspension; acier, noir / acier, tissu, noir, or

H 1100, Ø 430



E27



1x 60W



9 002759 495091





43848





43847



43849



### 43848 PLIMSOLL

pendant light; steel, wood, black  
Hängeleuchte; Stahl, Holz, schwarz  
luminaire en suspension; acier, bois, noir

L 770, B 95, H 1100



E27

4x 40W



9 002759 438487

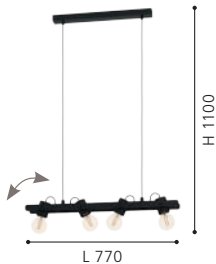

### 43847 PLIMSOLL

ceiling light; steel, wood, black  
Deckenleuchte; Stahl, Holz, schwarz  
plafonnier; acier, bois, noir

L 770, B 95, H 165



E27

4x 40W



9 002759 438470



### 43849 PLIMSOLL

table light; steel, wood, black  
Tischleuchte; Stahl, Holz, schwarz  
luminaire de table; acier, bois, noir

L 105, B 75, H 255, Base: Ø 135



E27

1x 40W



9 002759 438494

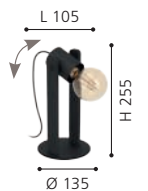

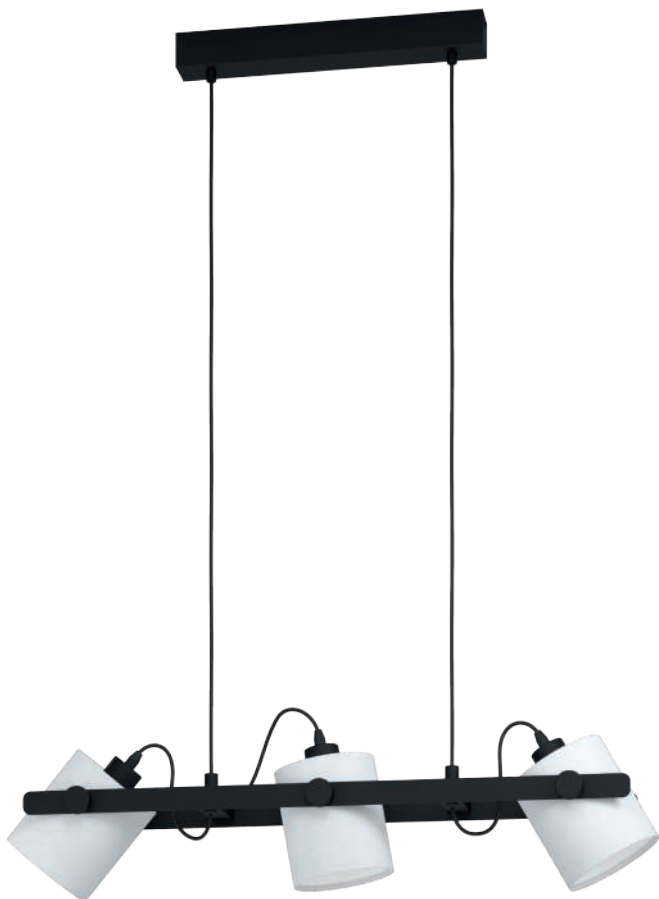

43426



43425



#### DETAIL HORNWOOD 1

The heads can be adjusted or fixed in position with the lateral screws.

Die Köpfe können mittels den seitlichen Schrauben verstellt oder fixiert werden.

Les têtes peuvent être réglées ou fixées à l'aide des vis latérales.

#### 43426 HORNWOOD 1

pendant light; steel, wood, black / fabric, white  
Hängeleuchte; Stahl, Holz, schwarz / Textil, weiss  
luminaire en suspension; acier, bois, noir / tissu, blanc

L 780, B 195, H 1100



E27



3x 28W



9 002759 434267



#### 43425 HORNWOOD 1

pendant light; steel, wood, black / fabric, white  
Hängeleuchte; Stahl, Holz, schwarz / Textil, weiss  
luminaire en suspension; acier, bois, noir / tissu, blanc

L 1100, B 180, H 1100



E27



4x 28W



9 002759 434250

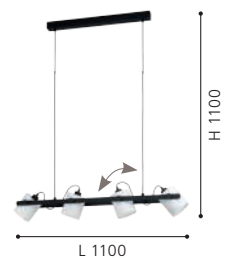



43428



43429



43427



### 43428 HORNWOOD 1

table light; steel, wood, black / fabric, white  
Tischleuchte; Stahl, Holz, schwarz / Textil, weiss  
luminaire de table; acier, bois, noir / tissu, blanc

L 195, H 425, Base: Ø 180



E27 1x 28W



9 002759 434281

### 43429 HORNWOOD 1

floor light; steel, wood, black / fabric, white  
Stehleuchte; Stahl, Holz, schwarz / Textil, weiss  
lampadaire; acier, bois, noir / tissu, blanc

L 215, H 1395, Base: Ø 230

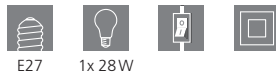

E27 1x 28W

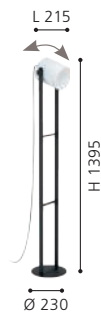

9 002759 434298

### 43427 HORNWOOD 1

wall light; steel, wood, black / fabric, white  
Wandleuchte; Stahl, Holz, schwarz / Textil, weiss  
applique; acier, bois, noir / tissu, blanc

L 195, A 255



E27 1x 28W



9 002759 434274



43141

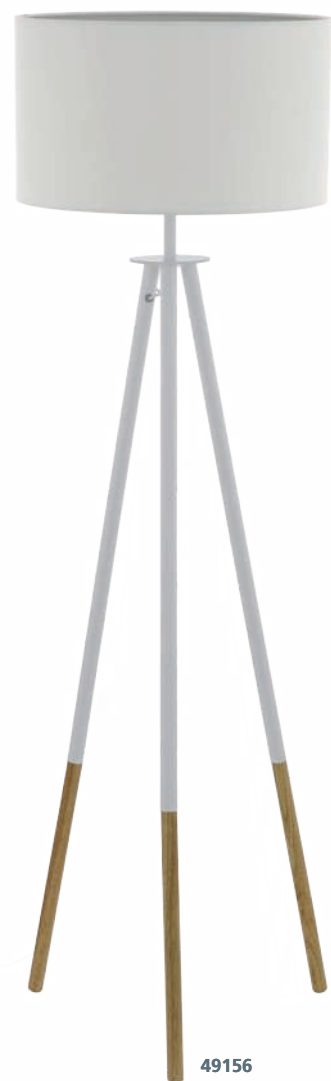

49156

### 43141 GLASTONBURY

floor light; steel, black / fabric, white  
 Stehleuchte; Stahl, schwarz / Textil, weiss  
 lampadaire; acier, noir / tissu, blanc

H 1510, Ø 240, Base: Ø 300



E27 1x 60W

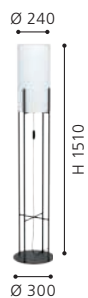

9 002759 431419

### 49156 BIDFORD

floor light; wood, steel, brown, white / fabric, white  
 Stehleuchte; Holz, Stahl, braun, weiss / Textil, weiss  
 lampadaire; bois, acier, marron, blanc / tissu, blanc

H 1540, Ø 460, Base: Ø 700



E27 1x 60W

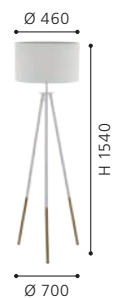

9 002759 491567



49148



94324



94326

### 49148 BIDFORD

floor light; wood, steel, brown / fabric, cappuccino, gold  
 Stehleuchte; Holz, Stahl, braun / Textil, cappuccino, gold  
 lampadaire; bois, acier, marron / tissu, cappuccino, or

H 1540, Ø 460, Base: Ø 700



E27 1x 60W



9 002759 491482

### 94324 LANTADA

floor light; wood, steel, natural / fabric, beige  
 Stehleuchte; Holz, Stahl, natur / Textil, beige  
 lampadaire; bois, acier, naturel / tissu, beige

H 1060 - 1430, Ø 450, Base: Ø 975



E27 1x 60W



9 002759 943240

### 94326 LANTADA

floor light; wood, steel, nut / fabric, taupe  
 Stehleuchte; Holz, Stahl, nuss / Textil, taupe  
 lampadaire; bois, acier, noisette / tissu, taupe

H 1060 - 1430, Ø 450, Base: Ø 975



E27 1x 60W



9 002759 943264



49386





49519



49385

### 49386 CHESTER

floor light; steel, black, copper  
 Stehleuchte; Stahl, schwarz, kupfer  
 lampadaire; acier, noir, cuivre

L 600, B 600, H 1495, Base: Ø 693



E27 1x 60W

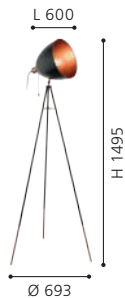

9 002759 493868

### 49519 CHESTER 1

floor light; steel, rust-coloured, gold  
 Stehleuchte; Stahl, rostfarben, gold  
 lampadaire; acier, rouille, or

L 600, B 600, H 1495, Base: Ø 693

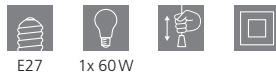

E27 1x 60W



9 002759 495190

### 49385 CHESTER

table light; steel, black, copper  
 Tischleuchte; Stahl, schwarz, kupfer  
 luminaire de table; acier, noir, cuivre

L 290, B 290, H 440



E27 1x 60W



9 002759 493851

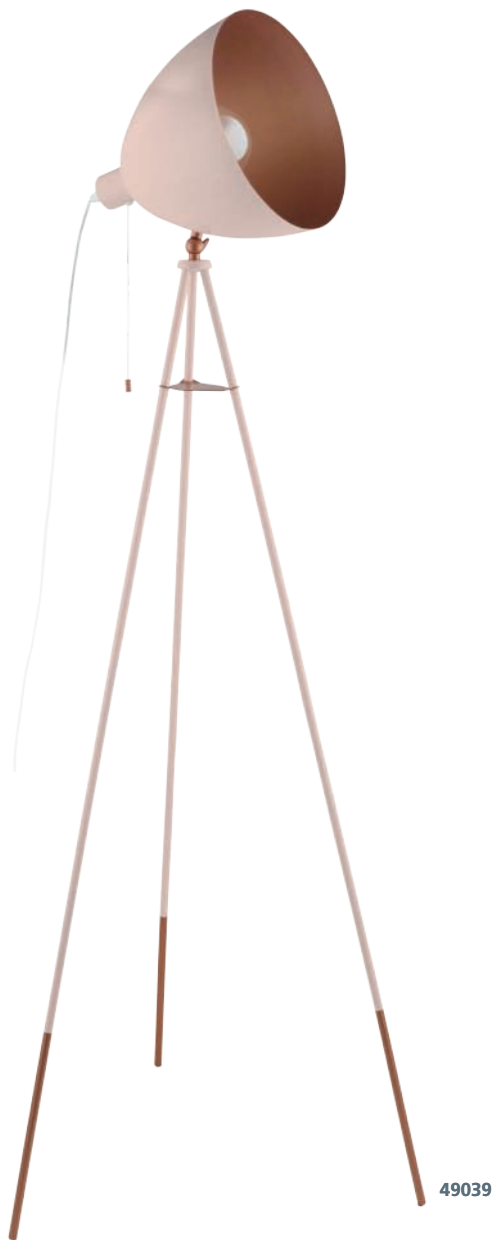

49039



49342

### 49039 CHESTER-P

floor light; steel, pastel apricot, copper  
Stehleuchte; Stahl, Pastell apricot, kupfer  
lampadaire; acier, pastel abricot, cuivre

L 600, B 600, H 1495, Base: Ø 693



E27 1x 60W

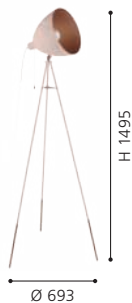

H 1495

Ø 693



9 002759 490393

### 49342 DUNDEE

floor light; steel, mint, copper-coloured / steel, mint, white  
Stehleuchte; Stahl, mint, kupferfarben / Stahl, mint, weiss  
lampadaire; acier, menthe, cuivré / acier, menthe, blanc

H 1355, Base: Ø 600



E27 1x 60W



H 1355

Ø 600



9 002759 493424

### 49337 DUNDEE

table light; steel, mint, copper-coloured / steel, mint, white  
Tischleuchte; Stahl, mint, kupferfarben / Stahl, mint, weiss  
luminaire de table; acier, menthe, cuivré / acier, menthe, blanc

H 440, Base: Ø 290



E27 1x 60W

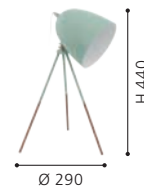

H 440

Ø 290



9 002759 493370



49337



43633



43634

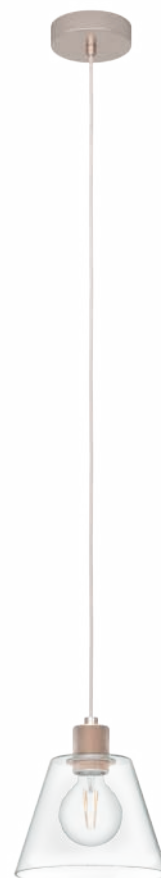

43631

### 43633 COPLEY

pendant light; steel, aluminium, gold-coloured / glass, clear  
Hängeleuchte; Stahl, Alu, goldfarben / Glas, klar  
luminaire en suspension; acier, aluminium, or / verre, transparent

H 1100, Ø 200



E27 1x 40W



9 002759 436339



### 43634 COPLEY

pendant light; steel, aluminium, gold-coloured / glass, clear  
Hängeleuchte; Stahl, Alu, goldfarben / Glas, klar  
luminaire en suspension; acier, aluminium, or / verre, transparent

L 900, B 200, H 1100



E27 3x 40W



9 002759 436346



### 43631 COPLEY

pendant light; steel, aluminium, rose gold / glass, clear  
Hängeleuchte; Stahl, Alu, roségold / Glas, klar  
luminaire en suspension; acier, aluminium, rose or / verre, transparent

H 1100, Ø 200



E27 1x 40W



9 002759 436315

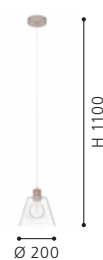



43632

### 43632 COPLEY

pendant light; steel, aluminium, rose gold / glass, clear  
Hängeleuchte; Stahl, Alu, roségold / Glas, klar  
luminaire en suspension; acier, aluminium, rose or / verre,  
transparent

L 900, B 200, H 1100



E27



3x 40W



9 002759 436322

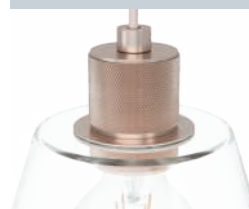

#### DETAIL COPLEY

This luminaire has a special socket.  
Diese Leuchte verfügt über eine  
spezielle Fassung.  
Cette luminaire a une douille spéciale.

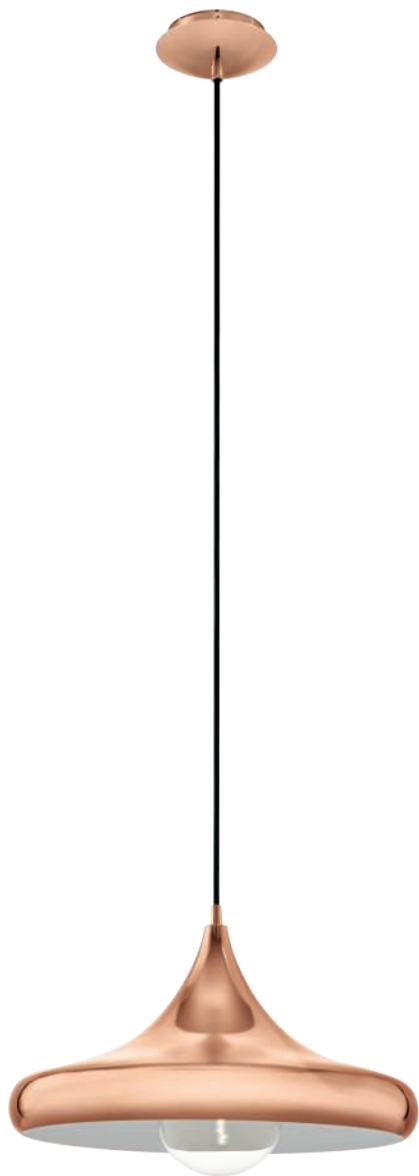

94742

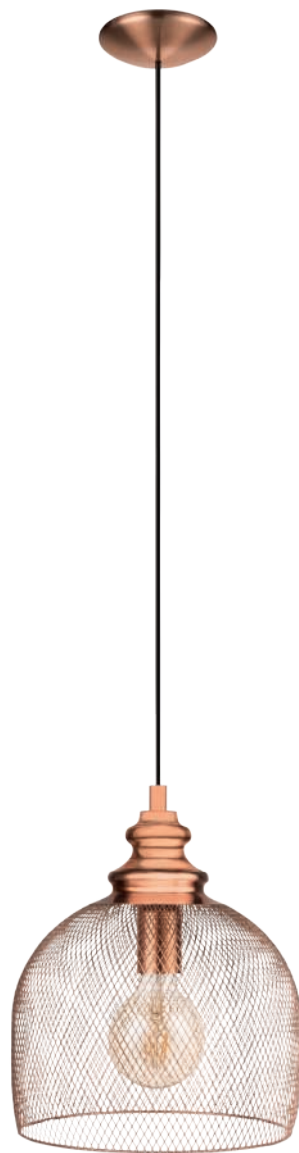

49738

### 94742 CORETTO 2

pendant light; steel, copper  
Hängeleuchte; Stahl, kupfer  
luminaire en suspension; acier, cuivre

H 1100, Ø 400



E27



1x 60W



9 002759 947422

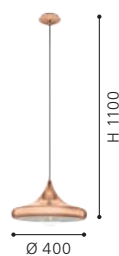

### 49738 STRAITON

pendant light; steel, copper  
Hängeleuchte; Stahl, kupfer  
luminaire en suspension; acier, cuivre

H 1100, Ø 280



E27



1x 60W



9 002759 497385

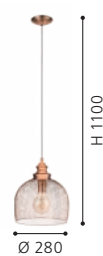

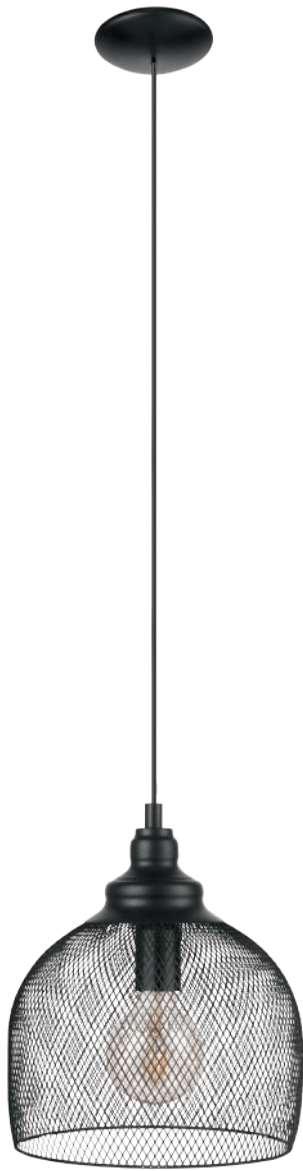

49736



49449

### 49736 STRAITON

pendant light; steel, black  
 Hängeleuchte; Stahl, schwarz  
 luminaire en suspension; acier, noir

H 1100, Ø 280



E27



1x 60W



9 002759 497361



### 49449 HAPTON

pendant light; steel, copper  
 Hängeleuchte; Stahl, kupfer  
 luminaire en suspension; acier, cuivre

H 1100, Ø 290



E27



1x 60W



9 002759 494490





43331

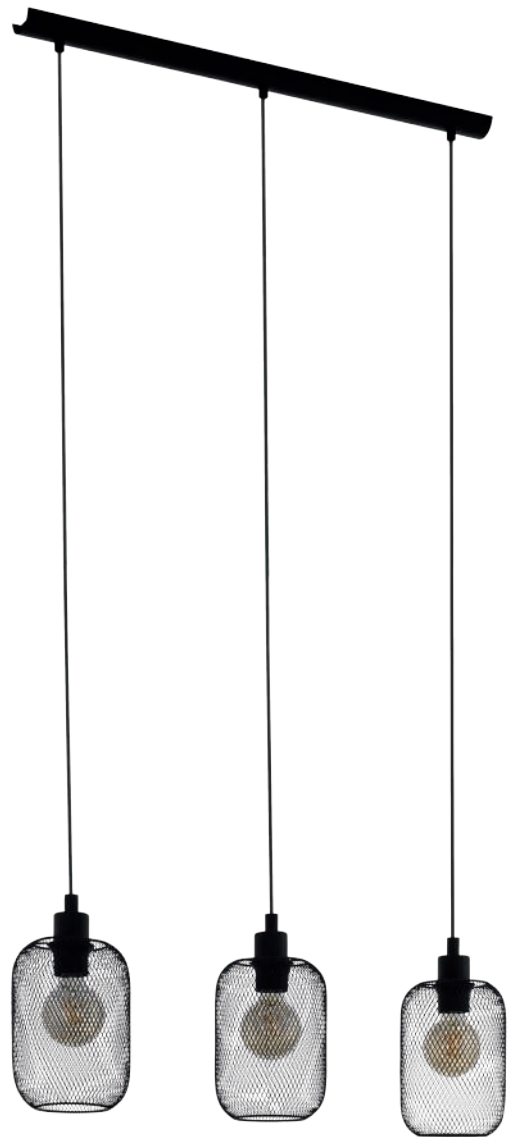

43333

### 43331 WRINGTON

pendant light; steel, black  
 Hängeleuchte; Stahl, schwarz  
 luminaire en suspension; acier, noir

H 1100, Ø 300



E27 1x 60W



9 002759 433314



### 43333 WRINGTON

pendant light; steel, black  
 Hängeleuchte; Stahl, schwarz  
 luminaire en suspension; acier, noir

L 740, B 150, H 1100



E27 3x 60W



9 002759 433338

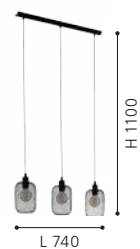





43334



43096



32468

### 43334 WRINGTON

pendant light; steel, black  
Hängeleuchte; Stahl, schwarz  
luminaire en suspension; acier, noir

H 1500, Ø 540



E27



5x 60W



9 002759 433345



### 43096 WRINGTON

table light; steel, black  
Tischleuchte; Stahl, schwarz  
luminaire de table; acier, noir

H 285, Ø 150, Base: Ø 100



E27



1x 60W



9 002759 430962



### 32468 WRINGTON

floor light; steel, black  
Stehleuchte; Stahl, schwarz  
lampadaire; acier, noir

L 635, B 300, H 1940, Base: Ø 300



E27



1x 60W



9 002759 324681

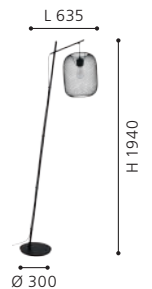

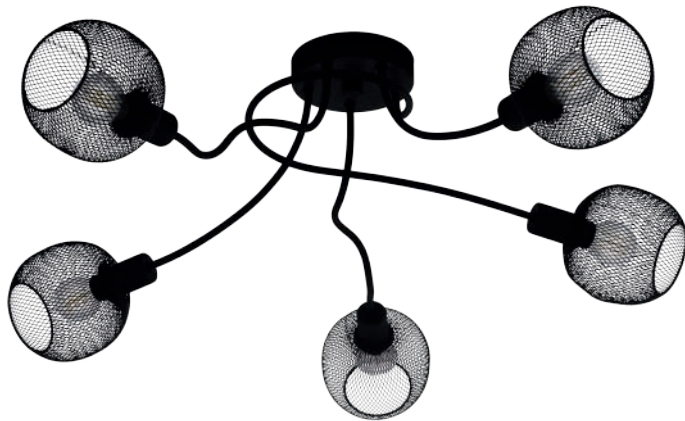

43374



43376

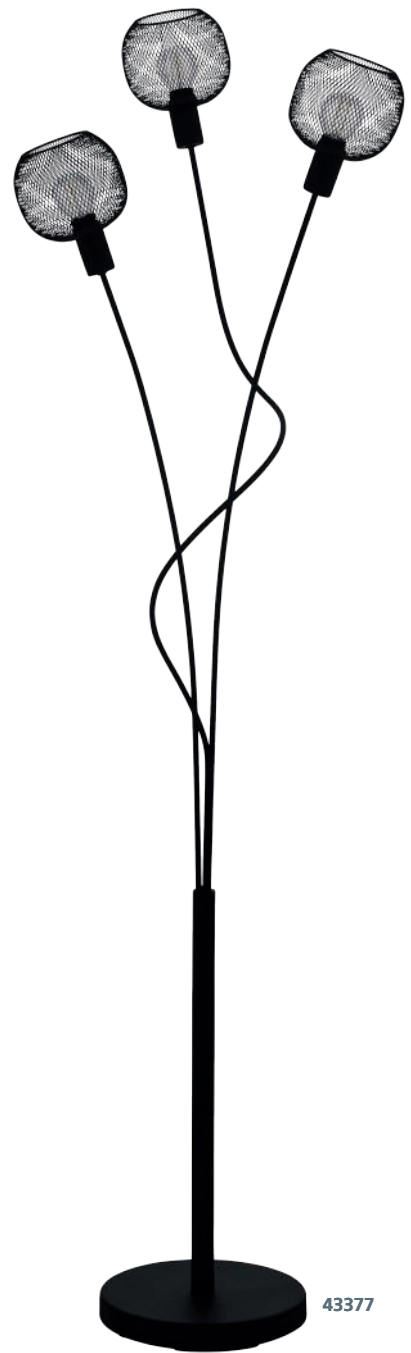

43377

### 43374 WRINGTON 1

ceiling light; steel, black  
Deckenleuchte; Stahl, schwarz  
plafonnier; acier, noir

H 255, Ø 755



E14 5x 40W



9 002759 433741

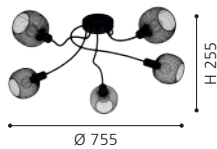

### 43376 WRINGTON 1

table light; steel, black  
Tischleuchte; Stahl, schwarz  
luminaire de table; acier, noir

L 305, B 195, H 405, Base: Ø 145



E14 2x 40W



9 002759 433765



### 43377 WRINGTON 1

floor light; steel, black  
Stehleuchte; Stahl, schwarz  
lampadaire; acier, noir

L 340, B 305, H 1495, Base: Ø 230



E14 3x 40W



9 002759 433772

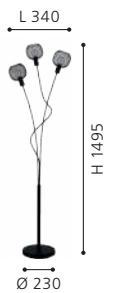



43375

### 43375 WRINGTON 1

wall light; steel, black  
Wandleuchte; Stahl, schwarz  
applique; acier, noir

L 385, H 355, A 195



E14



2x 40W



9 002759 433758

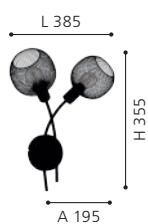



43303

### 43303 POMPEYA

ceiling light; steel, black  
Deckenleuchte; Stahl, schwarz  
plafonnier; acier, noir

L 450, B 440, H 255



E27



1x 60W



9 002759 433031

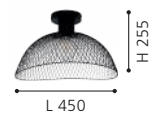

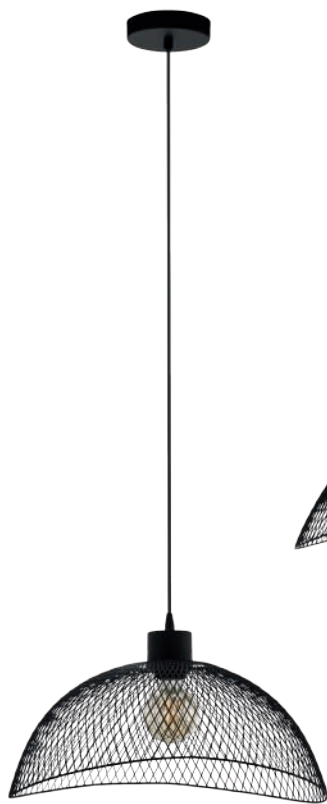

43304

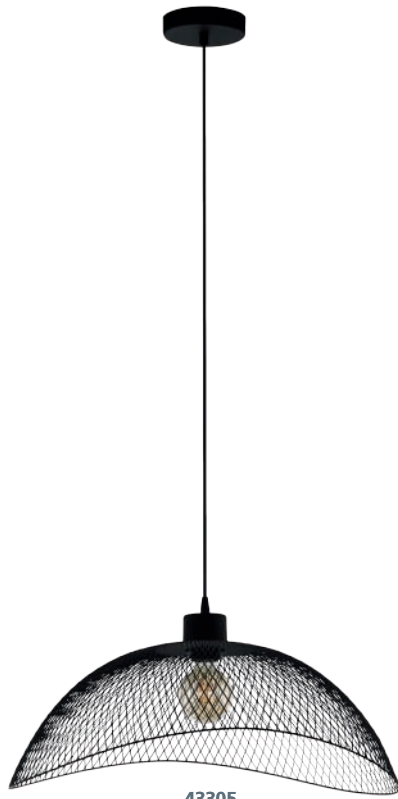

43305

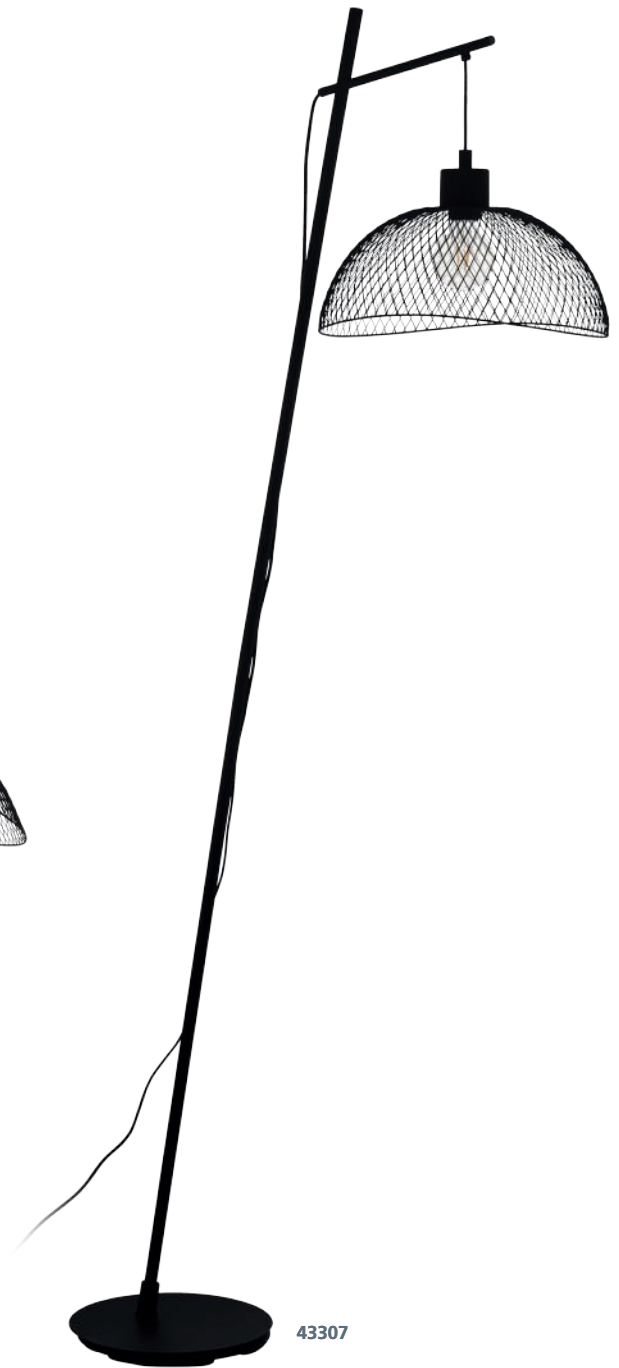

43307

### 43304 POMPEYA

pendant light; steel, black  
Hängeleuchte; Stahl, schwarz  
luminaire en suspension; acier, noir

L 450, B 440, H 1100



E27



1x 60W



9 002759 433048



### 43305 POMPEYA

pendant light; steel, black  
Hängeleuchte; Stahl, schwarz  
luminaire en suspension; acier, noir

L 570, B 540, H 1100



E27



1x 60W



9 002759 433055



### 43307 POMPEYA

floor light; steel, black  
Stehleuchte; Stahl, schwarz  
lampadaire; acier, noir

L 860, B 390, H 1910, Base: Ø 290



E27



1x 60W



9 002759 433079

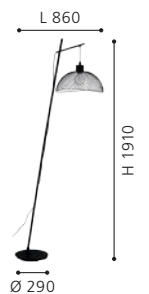



43669

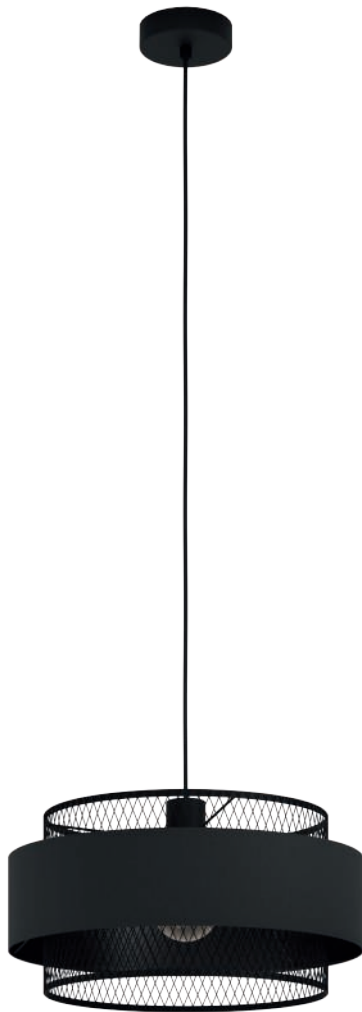

43668



43559

### 43669 BAZELY

pendant light; steel, black / fabric, black  
 Hängeleuchte; Stahl, schwarz / Textil, schwarz  
 luminaire en suspension; acier, noir / tissu, noir

L 990, B 230, H 1100



E27



3x 40W



9 002759 436698



### 43668 BAZELY

pendant light; steel, black / fabric, black  
 Hängeleuchte; Stahl, schwarz / Textil, schwarz  
 luminaire en suspension; acier, noir / tissu, noir

H 1100, Ø 400



E27



1x 40W



9 002759 436681



### 43559 SALLICANO

pendant light; steel, black, gold  
 Hängeleuchte; Stahl, schwarz, gold  
 luminaire en suspension; acier, noir, or

L 730, B 200, H 1100



E27



3x 40W



9 002759 435592





43841

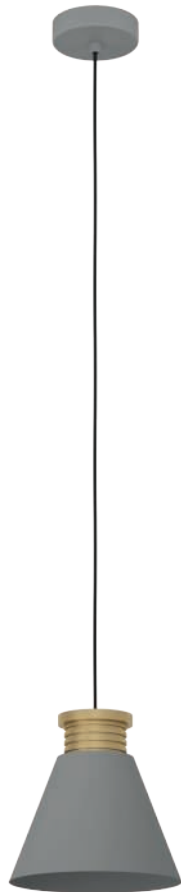

43838



43839

### 43841 TWICKEN

table light; steel, grey, gold  
Tischleuchte; Stahl, grau, gold  
luminaire de table; acier, gris, or

L 155, B 150, H 195, Base: B 155



E27 1x 28W



9 002759 438418

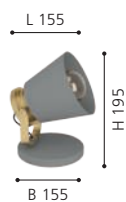

### 43838 TWICKEN

pendant light; steel, grey, gold  
Hängeleuchte; Stahl, grau, gold  
luminaire en suspension; acier, gris, or

H 1100, Ø 220



E27 1x 40W



9 002759 438388



### 43839 TWICKEN

pendant light; steel, grey, gold  
Hängeleuchte; Stahl, grau, gold  
luminaire en suspension; acier, gris, or

L 920, B 220, H 1100



E27 3x 40W



9 002759 438395

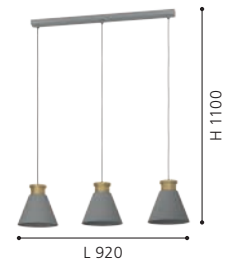





43835

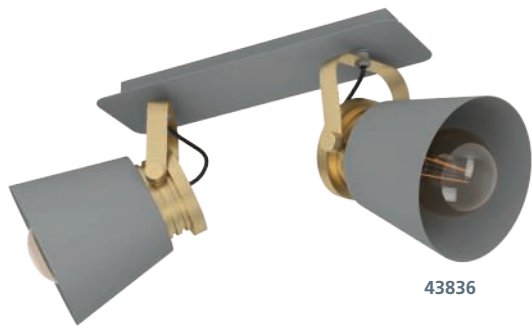

43836



43837

### 43835 TWICKEN

spot; steel, grey, gold  
Spot; Stahl, grau, gold  
spot; acier, gris, or

L 180, B 150, H 200



E27



1x 28W



9 002759 438357



L 180

H 200

### 43836 TWICKEN

spot; steel, grey, gold  
Spot; Stahl, grau, gold  
spot; acier, gris, or

L 370, B 205, H 175



E27



2x 40W



9 002759 438364



L 370

H 175

### 43837 TWICKEN

spot; steel, grey, gold  
Spot; Stahl, grau, gold  
spot; acier, gris, or

L 590, B 205, H 175



E27



3x 40W



9 002759 438371



L 590

H 175



43825

**DESIGN HIGHLIGHT**  
**DETAIL**

**43825 MATLOCK**  
pendant light; steel, grey, black  
Hängeleuchte; Stahl, grau, schwarz  
luminaire en suspension; acier, gris, noir

H 1100, Ø 380

    
E27 1x 40W

  
9 002759 438258



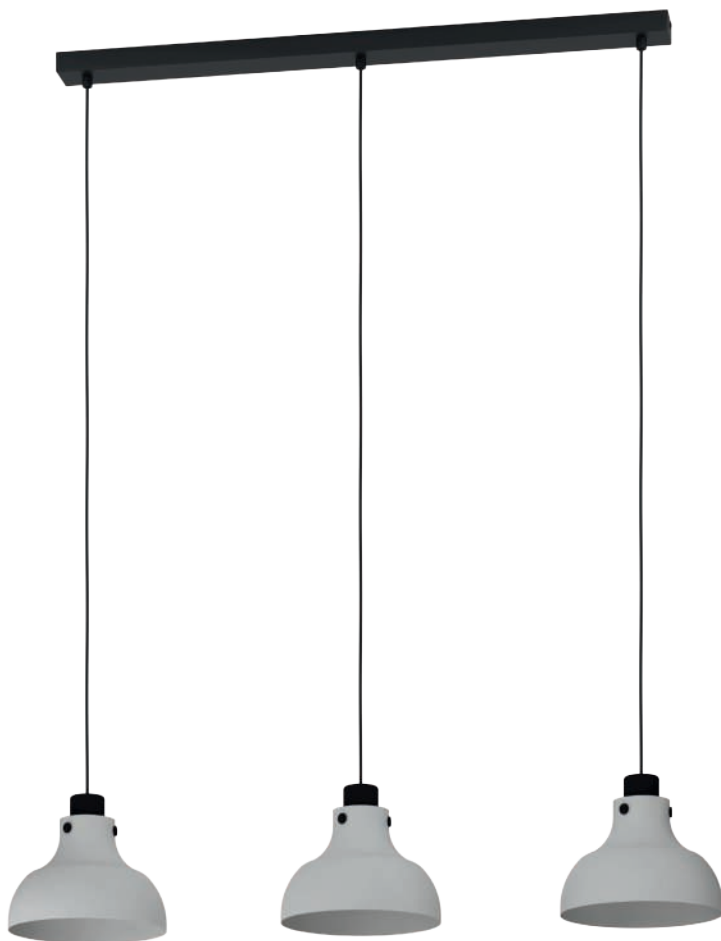

43826



43842



43844

### 43826 MATLOCK

pendant light; steel, grey, black  
Hängeleuchte; Stahl, grau, schwarz  
luminaire en suspension; acier, gris, noir

L 900, B 200, H 1100



E27



3x 40W



9 002759 438265

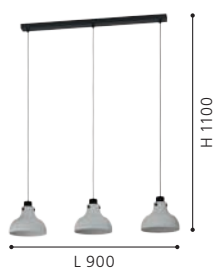

### 43842 MATLOCK

ceiling light; steel, grey, black  
Deckenleuchte; Stahl, grau, schwarz  
plafonnier; acier, gris, noir

H 210, Ø 380



E27



1x 40W



9 002759 438425



### 43844 MATLOCK

floor light; steel, grey, black  
Stehleuchte; Stahl, grau, schwarz  
lampadaire; acier, gris, noir

L 405, B 200, H 1580, Base: B 230



E27



1x 40W



9 002759 438449

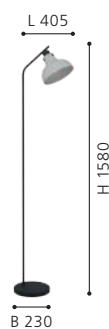



43829



43827



43828

### 43829 MATLOCK

spot; steel, wood, grey, black  
Spot; Stahl, Holz, grau, schwarz  
spot; acier, bois, gris, noir

L 740, B 145, H 225



E27 3x 40W



9 002759 438296



L 740

### 43827 MATLOCK

spot; steel, grey, black  
Spot; Stahl, grau, schwarz  
spot; acier, gris, noir

L 245, B 145, H 225



E27 1x 40W



9 002759 438272



L 245

H 225

### 43828 MATLOCK

spot; steel, wood, grey, black  
Spot; Stahl, Holz, grau, schwarz  
spot; acier, bois, gris, noir

L 520, B 145, H 225



E27 2x 40W



9 002759 438289



L 520

H 225



43843

### 43843 MATLOCK

wall light; steel, grey, black  
Wandleuchte; Stahl, grau, schwarz  
applique; acier, gris, noir

L 200, H 250, A 800



E27



1x 40W



9 002759 438432



39831



39832

### 39831 GIACONECCHIA

pendant light; steel, anthracite / terrazzo, grey  
Hängeleuchte; Stahl, anthrazit / Terrazzo, grau  
luminaire en suspension; acier, gris anthracite / terrazzo, gris

H 1100, Ø 105



E27



1x 40W



9 002759 398316



### 39832 GIACONECCHIA

pendant light; steel, anthracite / terrazzo, grey  
Hängeleuchte; Stahl, anthrazit / Terrazzo, grau  
luminaire en suspension; acier, gris anthracite / terrazzo, gris

L 975, B 55, H 1100



E27



4x 40W



9 002759 398323

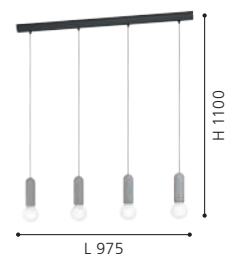

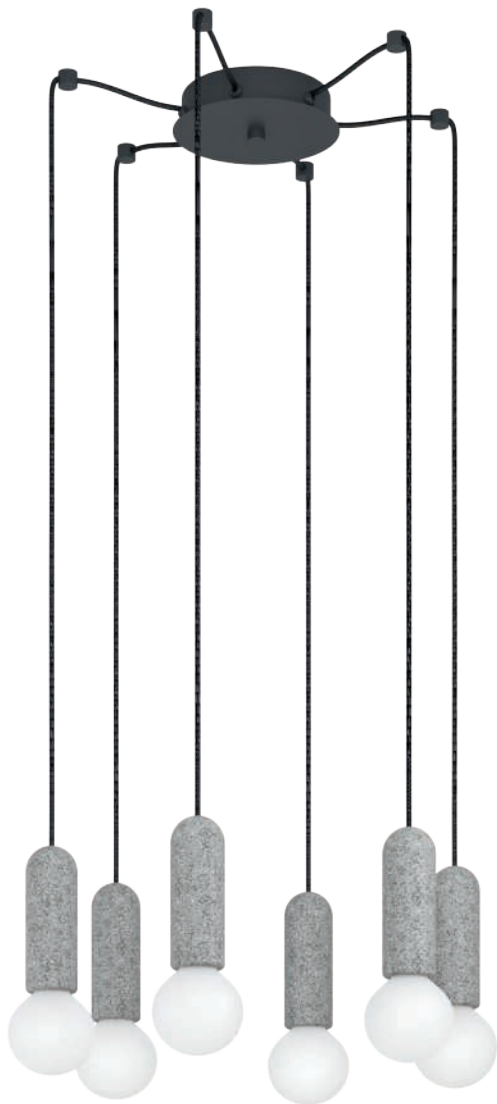

39833



39835



39834

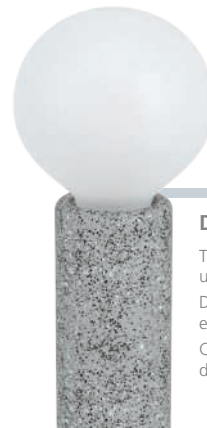

#### DETAIL GIACONECCHIA

These luminaires have a unique stone look.  
Diese Leuchten haben eine einzigartige Steinoptik.  
Ces lumières ont un aspect de pierre unique.

#### 39833 GIACONECCHIA

pendant light; steel, anthracite / terrazzo, grey  
Hängeleuchte; Stahl, anthrazit / Terrazzo, grau  
luminaire en suspension; acier, gris anthracite / terrazzo, gris

H 1500, Ø 535



E27 6x 40W



9 002759 398330

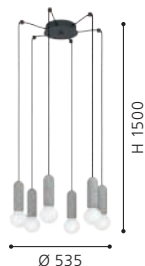

#### 39835 GIACONECCHIA

table light; steel, anthracite / terrazzo, grey  
Tischleuchte; Stahl, anthrazit / Terrazzo, grau  
luminaire de table; acier, gris anthracite / terrazzo, gris

H 175, Ø 55, Base: Ø 130



E27 1x 40W



9 002759 398354



#### 39834 GIACONECCHIA

wall light; steel, anthracite / terrazzo, grey  
Wandleuchte; Stahl, anthrazit / Terrazzo, grau  
applique; acier, gris anthracite / terrazzo, gris

L 55, H 205, A 105



E27 1x 40W



9 002759 398347





43595

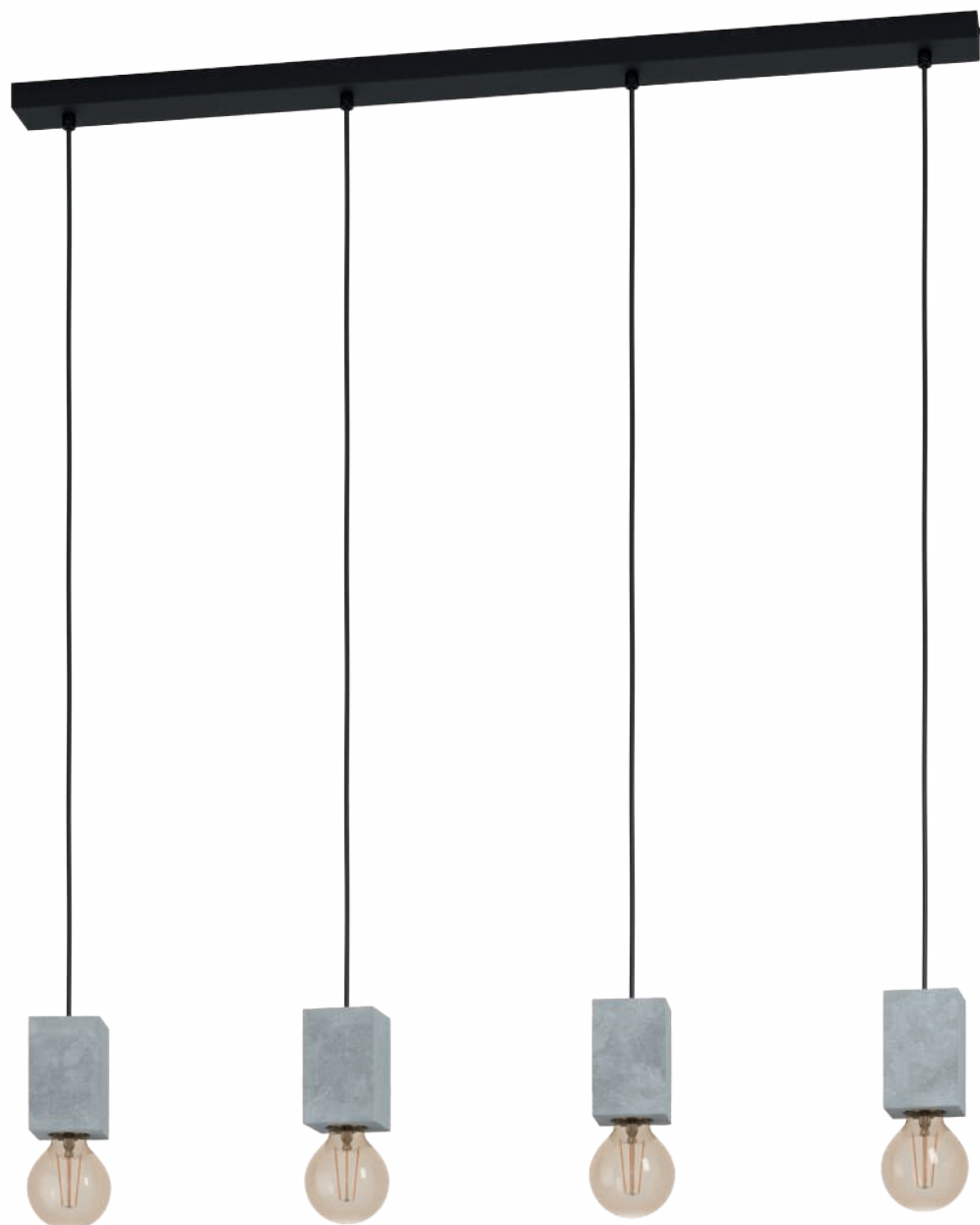

43598

### 43595 PRESTWICK 3

ceiling light; steel, black / concrete, grey  
Deckenleuchte; Stahl, schwarz / Beton, grau  
plafonnier; acier, noir / béton, gris

L 90, B 90, H 110



E27



1x 40W



9 002759 435950



### 43598 PRESTWICK 3

pendant light; steel, black / concrete, grey  
Hängeleuchte; Stahl, schwarz / Beton, grau  
luminaire en suspension; acier, noir / béton, gris

L 925, B 55, H 1100



E27



4x 40W



9 002759 435981

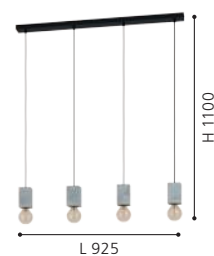





43597



43596

### 43597 PRESTWICK 3

pendant light; steel, black / concrete, grey  
 Hängeleuchte; Stahl, schwarz / Beton, grau  
 luminaire en suspension; acier, noir / béton, gris

H 1100, Ø 70



E27



1x 40W



9 002759 435974



### 43596 PRESTWICK 3

ceiling light; steel, black / concrete, grey  
 Deckenleuchte; Stahl, schwarz / Beton, grau  
 plafonnier; acier, noir / béton, gris

L 490, B 90, H 110



E27



3x 40W



9 002759 435967

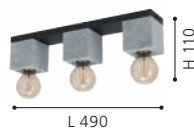



49812



49111

### 49812 PRESTWICK

table light; ceramic, grey  
Tischleuchte; Keramik, grau  
luminaire de table; céramique, gris

L 90, B 90, H 130



E27 1x 60W



9 002759 498122



### 49111 LYNTON

table light; concrete, grey  
Tischleuchte; Beton, grau  
luminaire de table; béton, gris

H 270, Ø 140



E27 1x 60W



9 002759 491116



### 43615 FRIJOLAS

table light; steel, black  
Tischleuchte; Stahl, schwarz  
luminaire de table; acier, noir

L 240, B 30, H 245, Base: Ø 120

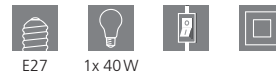

E27 1x 40W



9 002759 436155





43615

# VINTAGE

Did you know that the word Vintage originally meant „wine harvest“? Vintage style means a piece of furniture built anew but designed in a „used look“. Genuine vintage pieces from the 1920s to 1980s can be found in flea markets or in the attic, by contrast. Genuine or as imitations: Vintage reminds us of the good old days: summer holidays with the grandparents, the first ride in grandpa's vintage car and the best apple pie from grandma's enamelled mould. Travel through time, and enjoy feelings of nostalgia with a glass of wine. We recommend accompanying the wine with a taste of our vintage product range.

Wussten Sie, dass das Wort Vintage ursprünglich „Weinlese“ bedeutet? Vom Vintage-Stil spricht man, wenn ein Einrichtungsstück neu gebaut, aber im „Used-Look“ designt ist. Echte Vintage-Stücke aus den 20er bis 80er-Jahren findet man hingegen auf Flohmärkten oder am Dachboden. Ob echt oder nachgebaut, Vintage erinnert uns an die gute alte Zeit: Sommerferien bei den Großeltern, die erste Fahrt mit Opas Oldtimer und der beste Apfelkuchen aus Omas Emaille-Form. Erleben Sie eine Zeitreise, schwelgen Sie in Nostalgiegefühlen und schenken Sie sich ein Glas Wein ein. Als Weinbegleitung empfehlen wir ein Reinschnuppern in unsere Vintage-Produktserie.

Est-ce que vous saviez que le mot Vintage voulait originellement dire « vendanges » ? Lorsqu'une pièce de décor est fabriquée à neuf, mais qu'elle est conçue dans le « Used-Look » (look usé), l'on parle de style Vintage. Contrairement, des vraies pièces Vintage, des années 20 jusqu'aux années 80, se trouvent soit sur le marché aux puces, soit au grenier. Qu'elles soient réelles ou imitées, Vintage nous rappelle le bon vieux temps : les vacances d'été chez les grands-parents, la première conduite avec la voiture de collection du grand-père et la meilleure tarte aux pommes du moule en émail de la grand-mère. Découvrez un voyage dans le temps, festoyez dans des sentiments nostalgiques et versez-vous un verre de vin. Nous recommandons, comme accompagnement de vin, un reniflement dans notre série de produit Vintage.





VINOZA  
p. 196



GILTSPUR  
p. 198



CHISLE  
p. 199



RUSCOMB  
p. 200



WOOTTON  
p. 202-203



YOUNGSTOWN  
p. 204



RAMPSIDE 1  
p. 204



FINDLAY  
p. 205



RAMPSIDE  
p. 205-207



COTTINGHAM  
p. 208



TARLE  
p. 208



PADSTOW  
p. 208-209



HORNINGTOPS  
p. 209



RODING  
p. 210



HODSOLL  
p. 211



CHERTSEY  
p. 212



MEOPHAM  
p. 212



STOCKBURY  
p. 213



HOGSMILL  
p. 214



BRIDPORT  
p. 215



LATCHELY  
p. 215



This product is available in different colors and shapes./ Dieser Artikel ist in unterschiedlichen Farben und Formen verfügbar.  
Cet article est disponible en différentes couleurs et formes.



43824

### 43824 VINOZA

table light; ceramic, white / fabric, black  
 Tischleuchte; Keramik, weiss / Textil, schwarz  
 luminaire de table; céramique, blanc / tissu, noir

H 505, Ø 300, Base: Ø 120



E27 1x 40W



9 002759 438241



### 43823 VINOZA

table light; ceramic, black / fabric, white  
 Tischleuchte; Keramik, schwarz / Textil, weiss  
 luminaire de table; céramique, noir / tissu, blanc

H 505, Ø 300, Base: Ø 120



E27 1x 40W



9 002759 438234





43823



43554



43553

### 43554 GILTSPUR

pendant light; steel, black  
Hängeleuchte; Stahl, schwarz  
luminaire en suspension; acier, noir

L 770, B 180, H 1100



E27



3x 40W



9 002759 435547



### 43553 GILTSPUR

ceiling light; steel, black  
Deckenleuchte; Stahl, schwarz  
plafonnier; acier, noir

H 230, Ø 550



E27



3x 40W



9 002759 435530

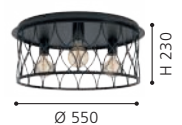





43527



43499



43528



### DETAIL CHISLE

The mixture of steel and vaporized glass gives these luminaires a unique look.

Die Mischung aus Stahl und bedampftem Glas verleiht diesen Leuchten eine besondere Optik. Le mélange d'acier et de verre vaporisé donne à ces luminaires un look unique.

### 43527 CHISLE

pendant light; steel, black, bronzed / glass vaporized, amber  
Hängeleuchte; Stahl, schwarz, brüniert / Glas bedampft, ambre  
luminaire en suspension; acier, noir, brun / verre vaporisé, ambre

H 1100, Ø 165



E27



1x 40W



9 002759 435271



### 43499 CHISLE

pendant light; steel, black, bronzed / glass vaporized, amber  
Hängeleuchte; Stahl, schwarz, brüniert / Glas bedampft, ambre  
luminaire en suspension; acier, noir, brun / verre vaporisé, ambre

H 1300, Ø 425



E27



3x 40W



9 002759 434991



### 43528 CHISLE

pendant light; steel, black, bronzed / glass vaporized, amber  
Hängeleuchte; Stahl, schwarz, brüniert / Glas bedampft, ambre  
luminaire en suspension; acier, noir, brun / verre vaporisé, ambre

L 1300, B 165, H 1100



E27



4x 40W



9 002759 435288

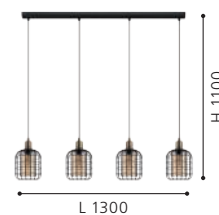



43494



43495

### 43494 RUSCOMB

spot; steel, black / paper, plastic, natural  
Spot; Stahl, schwarz / Papier, Kunststoff, natur  
spot; acier, noir / papier, plastique, nature

L 440, H 175, A 285



E27 2x 10W



9 002759 434946



### 43495 RUSCOMB

spot; steel, black / paper, plastic, natural  
Spot; Stahl, schwarz / Papier, Kunststoff, natur  
spot; acier, noir / papier, plastique, nature

L 775, H 175, A 235



E27 3x 10W



9 002759 434953



### 43493 RUSCOMB

spot; steel, black / paper, plastic, natural  
Spot; Stahl, schwarz / Papier, Kunststoff, natur  
spot; acier, noir / papier, plastique, nature

L 135, H 175, A 210



E27 1x 10W



9 002759 434939





43493

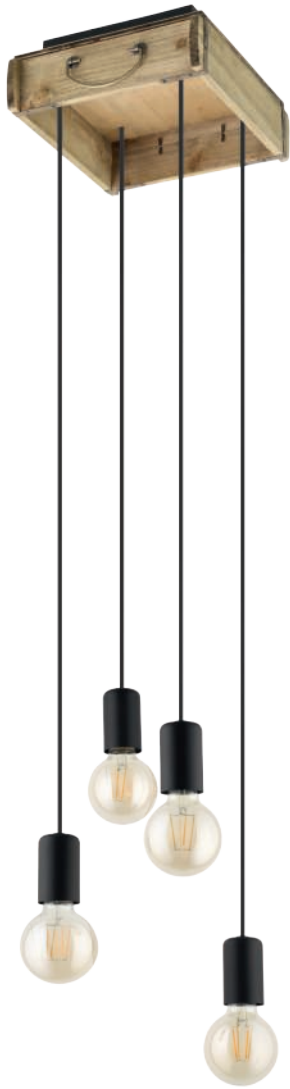

43591



43593



43592

### 43591 WOOTTON

pendant light; wood, steel, brown, black  
 Hängeleuchte; Holz, Stahl, braun, schwarz  
 luminaire en suspension; bois, acier, marron, noir

L 250, B 280, H 1100



E27 4x 40W



9 002759 435912



### 43593 WOOTTON

wall light; wood, steel, brown, black  
 Wandleuchte; Holz, Stahl, braun, schwarz  
 applique; bois, acier, marron, noir

L 145, H 270, A 115



E27 1x 40W



9 002759 435936



### 43592 WOOTTON

pendant light; wood, steel, brown, black  
 Hängeleuchte; Holz, Stahl, braun, schwarz  
 luminaire en suspension; bois, acier, marron, noir

L 810, B 220, H 1100



E27 6x 40W



9 002759 435929





43594

### 43594 WOOTTON

table light; wood, steel, brown, black  
Tischleuchte; Holz, Stahl, braun, schwarz  
luminaire de table; bois, acier, marron, noir

L 250, B 220, H 375



E27



3x 40W



9 002759 435943



DESIGN  
HIGHLIGHT  
DETAIL



43318



43319



43351

### 43318 YOUNGSTOWN

pendant light; steel, wood, black, brown  
 Hängeleuchte; Stahl, Holz, schwarz, braun  
 luminaire en suspension; acier, bois, noir, marron

L 700, B 45, H 1100



E27 4x 40W



9 002759 433185



### 43319 YOUNGSTOWN

pendant light; steel, wood, black, brown  
 Hängeleuchte; Stahl, Holz, schwarz, braun  
 luminaire en suspension; acier, bois, noir, marron

L 1000, B 45, H 1100



E27 6x 40W



9 002759 433192



### 43351 RAMPSIDE 1

wall light; wood, natural / steel, black  
 Wandleuchte; Holz, natur / Stahl, schwarz  
 applique; bois, naturel / acier, noir

L 140, H 330, A 240



E27 1x 40W



9 002759 433512





49694



43194

### 49694 FINDLAY

pendant light; steel, black  
Hängeleuchte; Stahl, schwarz  
luminaire en suspension; acier, noir

H 1500, Ø 560



E27



6x 60W



9 002759 496944

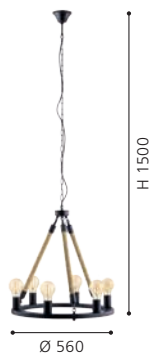

H 1500

Ø 560

### 43194 RAMPSIDE

pendant light; steel, black  
Hängeleuchte; Stahl, schwarz  
luminaire en suspension; acier, noir

H 1090, Ø 760



E27



6x 28W



9 002759 431945



H 1090

Ø 760



43195



43256

#### DETAIL 43195

The luminaire heads can be installed on the ceiling individually.  
Die Leuchtenköpfe können individuell an die Decke montiert werden.

Les têtes de luminaires peuvent être montées individuellement au plafond.

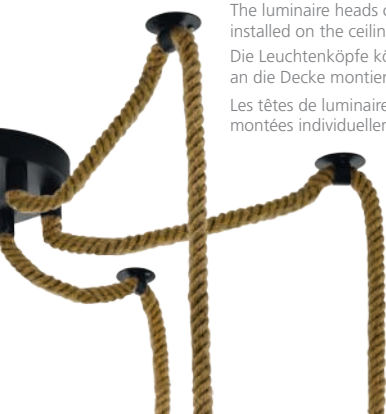

43197

#### 43195 RAMPSIDE

pendant light; steel, black  
Hängeleuchte; Stahl, schwarz  
luminaire en suspension; acier, noir

H 1590, Ø 180



E27 6x 28W



9 002759 431952

#### 43197 RAMPSIDE

wall light; steel, wood, black, brown  
Wandleuchte; Stahl, Holz, schwarz, braun  
applique; acier, bois, noir, marron

L 80, H 300, A 135

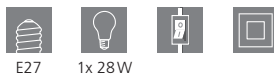

E27 1x 28W



9 002759 431976

#### 43256 RAMPSIDE

pendant light; steel, black  
Hängeleuchte; Stahl, schwarz  
luminaire en suspension; acier, noir

H 1380, Ø 110



E27 1x 28W

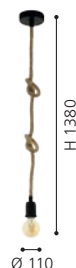

9 002759 432560





43192



43199

### 43192 RAMPSIDE

pendant light; steel, black / glass vaporized, amber  
 Hängeleuchte; Stahl, schwarz / Glas bedampft, amber  
 luminaire en suspension; acier, noir / verre vaporisé, ambre

L 895, B 195, H 1230



E27



3x 28W



9 002759 431921



### 43199 RAMPSIDE

table light; steel, black / fabric, creme  
 Tischleuchte; Stahl, schwarz / Textil, creme  
 luminaire de table; acier, noir / tissu, crème

H 400, Ø 190, Base: Ø 145



E27



1x 28W



9 002759 431990





43328

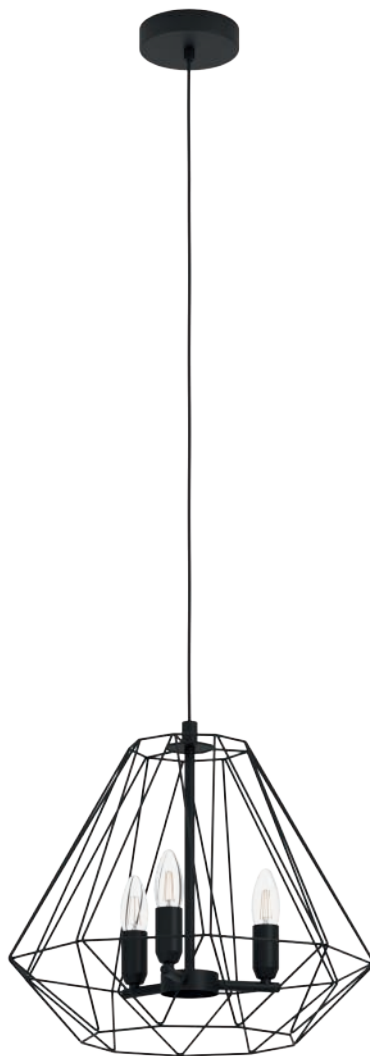

43845

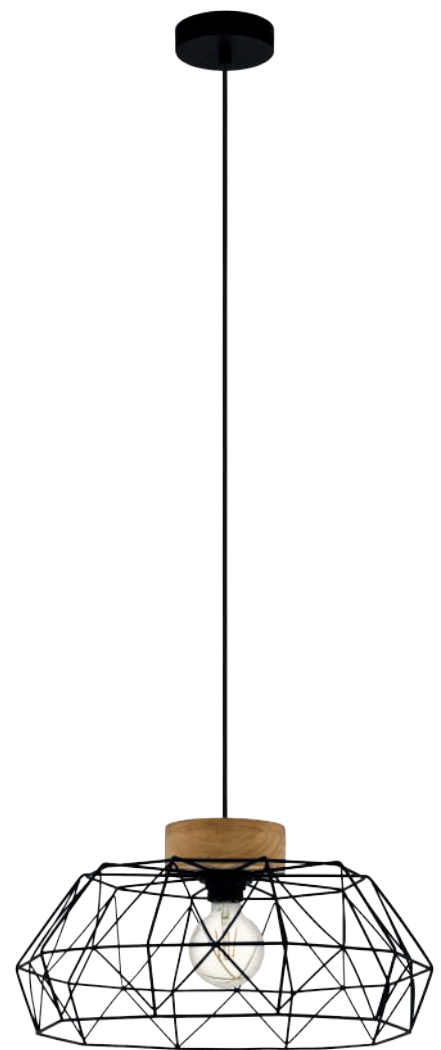

43364

### 43328 COTTINGHAM

pendant light; steel, black  
Hängeleuchte; Stahl, schwarz  
luminaire en suspension; acier, noir

H 1100, Ø 370



E27 1x 40W



9 002759 433284

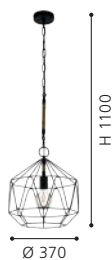

### 43845 TARLE

pendant light; steel, black  
Hängeleuchte; Stahl, schwarz  
luminaire en suspension; acier, noir

H 1100, Ø 445



E14 3x 40W



9 002759 438456



### 43364 PADSTOW

pendant light; steel, wood, black, natural  
Hängeleuchte; Stahl, Holz, schwarz, natur  
luminaire en suspension; acier, bois, noir, naturel

H 1100, Ø 455



E27 1x 60W



9 002759 433642

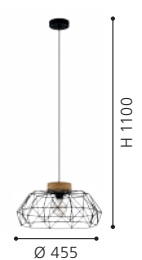



43363



43352

### 43363 PADSTOW

ceiling light; steel, wood, black, natural  
Deckenleuchte; Stahl, Holz, schwarz, natur  
plafonnier; acier, bois, noir, naturel

H 205, Ø 455



E27



1x 60W



9 002759 433635



### 43352 HORNINGTOPS

pendant light; steel, wood, black, natural  
Hängeleuchte; Stahl, Holz, schwarz, natur  
luminaire en suspension; acier, bois, noir, naturel

L 760, B 150, H 1100



E27



3x 40W



9 002759 433529





43619



43617



43618

### 43619 RODING

wall light; steel, wood, black, brown / glass, clear  
Wandleuchte; Stahl, Holz, schwarz, braun / Glas, klar  
applique; acier, bois, noir, marron / verre, transparent

L 180, H 350, A 180



E27



1x 40W



9 002759 436193



### 43617 RODING

pendant light; steel, wood, black, brown / glass, clear  
Hängeleuchte; Stahl, Holz, schwarz, braun / Glas, klar  
luminaire en suspension; acier, bois, noir, marron / verre, transparent

H 1100, Ø 180



E27



1x 40W



9 002759 436179



### 43618 RODING

pendant light; steel, wood, black, brown / glass, clear  
Hängeleuchte; Stahl, Holz, schwarz, braun / Glas, klar  
luminaire en suspension; acier, bois, noir, marron / verre, transparent

L 880, B 180, H 1100



E27



3x 40W



9 002759 436186





43397



43396



### 43397 HODSOLL

pendant light; steel, wood, black, brown rustic / steel, black, creme

Hängeleuchte; Stahl, Holz, schwarz, braun rustikal / Stahl, schwarz, creme

luminaire en suspension; acier, bois, noir, marron rustique / acier, noir, crème

L 1250, B 400, H 1100



E27



2x 40W



9 002759 433970



### 43396 HODSOLL

pendant light; steel, wood, black, brown rustic / steel, black, creme

Hängeleuchte; Stahl, Holz, schwarz, braun rustikal / Stahl, schwarz, creme

luminaire en suspension; acier, bois, noir, marron rustique / acier, noir, crème

L 350, B 400, H 1100



E27



1x 40W



9 002759 433963



#### DETAIL HODSOLL

The mounting bracket of the light fitting can be individually adjusted.  
Die Aufhängung der Leuchtenköpfe kann individuell eingestellt werden.  
La suspension des têtes de luminaire est réglable.



43405



43404

### 43405 CHERTSEY

pendant light; steel, leather, black / steel, zinc-plated  
Hängeleuchte; Stahl, Leder, schwarz / Stahl, verzinkt  
luminaire en suspension; acier, cuir, noir / acier, galvanisé

H 1100, Ø 335



E27



1x 60W



9 002759 434052



H 1100

Ø 335

### 43404 MEOPHAM

pendant light; steel, auburn  
Hängeleuchte; Stahl, rostbraun  
luminaire en suspension; acier, brun rouille

H 1100, Ø 240



E27



1x 60W



9 002759 434045



H 1100

Ø 240

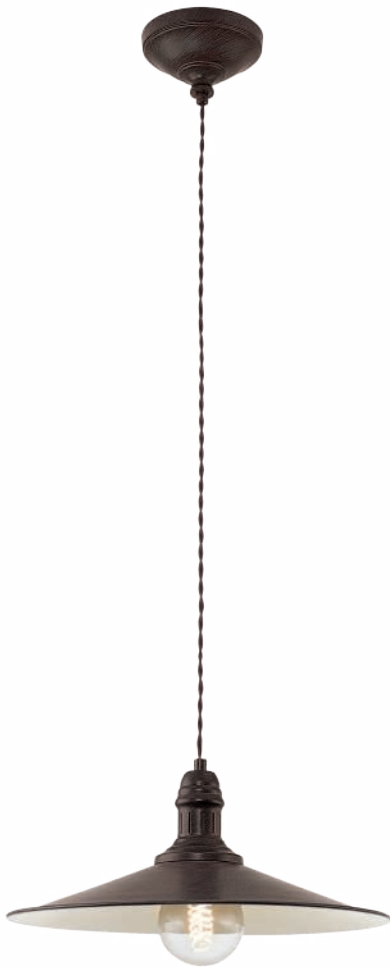

49456



49457



49458

### 49456 STOCKBURY

pendant light; steel, antique-brown, beige  
Hängeleuchte; Stahl, antik-braun, beige  
luminaire en suspension; acier, marron antique, beige

H 1100, Ø 360



E27



1x 60W



9 002759 494568

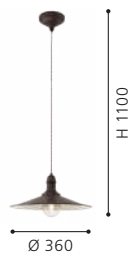

### 49457 STOCKBURY

pendant light; steel, antique-brown, beige  
Hängeleuchte; Stahl, antik-braun, beige  
luminaire en suspension; acier, marron antique, beige

L 800, B 300, H 1100



E27



2x 60W



9 002759 494575



### 49458 STOCKBURY

wall light; steel, antique-brown, beige  
Wandleuchte; Stahl, antik-braun, beige  
applique; acier, marron antique, beige

L 210, H 225, A 270



E27



1x 60W



9 002759 494582





43322

#### DETAIL 43322

The canopy design enables the position of the light fitting to be individually adjusted.

Durch den besondern Baldachin ist die Position der Leuchtmittel individuell verstellbar.

Dies ist ein Platzhalter Grâce à son dais spécial, la position de chaque ampoule peut être ajustée.



#### 43322 HOGSMILL

pendant light; steel, black  
Hängeleuchte; Stahl, schwarz  
luminaire en suspension; acier, noir

L 1155, B 405, H 1100



E27



8x 40W



9 002759 433222

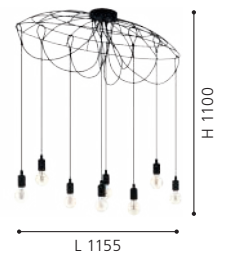



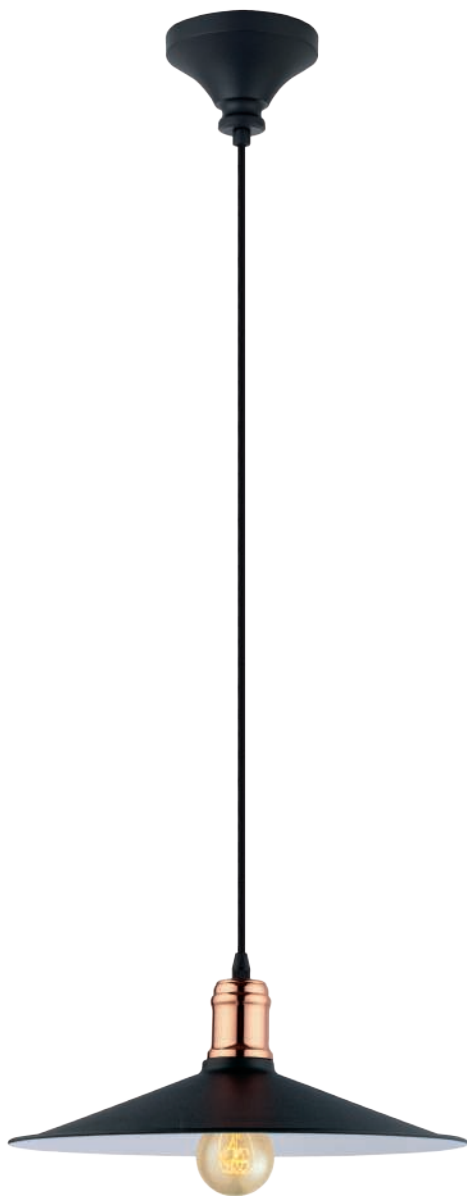

49452

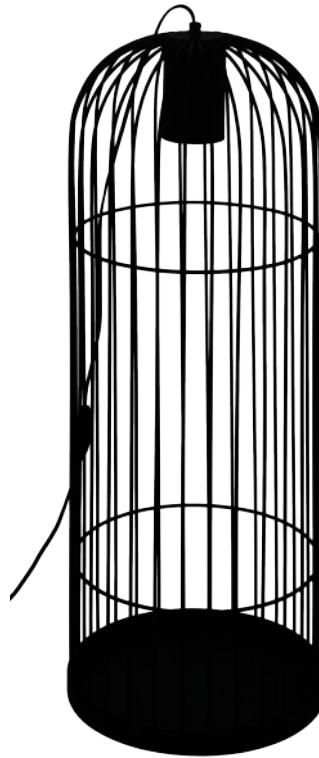

43389



### 49452 BRIDPORT

pendant light; steel, black, copper  
 Hängeleuchte; Stahl, schwarz, kupfer  
 luminaire en suspension; acier, noir, cuivre

H 1100, Ø 360



E27



1x 60W



9 002759 494520

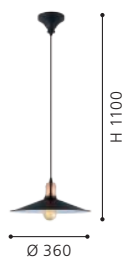

### 43389 LATCHELY

floor light; steel, black  
 Stehleuchte; Stahl, schwarz  
 lampadaire; acier, noir

H 720, Ø 275



GU10



1x 4,6W



warm  
 WHITE  
 1x  
 400lm



9 002759 433895

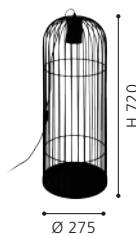

# NATURE

Bring the warmth and comfort of natural elements into your home. The back-to-nature trend incorporates designs that use natural materials, harmonious colour combinations, and simple, neutral shapes. A lamp from the EGLO Nature range will increase the comfort of any living space, no matter what interior design style you prefer.

Holen Sie sich pure Gemütlichkeit in Ihr zu Hause, ganz getreu dem Motto „back to nature“. Der Nature-Trend umfasst Designs mit natürlichen Materialien, aufeinander abgestimmten Farbkombinationen und neutralen sowie einfachen Formen. Egal welchen Einrichtungsstil Sie bevorzugen, mit einer EGLO Leuchte aus der Kategorie Nature steigern Sie das Wohlbefinden im Wohnraum.

Faites entrer le confort absolu dans votre maison, fidèle à la devise „retour à la nature“. La tendance nature comprend des designs avec des matériaux naturels, des combinaisons de couleurs coordonnées et des formes neutres et simples. Quel que soit le style d'ameublement que vous préférez, avec une lampe EGLO de la catégorie Nature, vous augmentez le bien-être dans le salon.





This product is available in different colors and shapes./ Dieser Artikel ist in unterschiedlichen Farben und Formen verfügbar.  
Cet article est disponible en différentes couleurs et formes.



43785



43786



43784

### 43784 ALDERNEY

ceiling light; steel, black / textile thread, natural  
Deckenleuchte; Stahl, schwarz / Textilfaden, natur  
plafonnier; acier, noir / fil textile, nature

H 240, Ø 480



E27



1x 40W



9 002759 437848

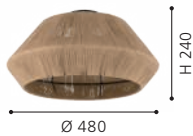

### 43785 ALDERNEY

pendant light; steel, black / textile thread, natural  
Hängeleuchte; Stahl, schwarz / Textilfaden, natur  
luminaire en suspension; acier, noir / fil textile, nature

H 1100, Ø 300



E27



1x 40W



9 002759 437855



### 43786 ALDERNEY

pendant light; steel, black / textile thread, natural  
Hängeleuchte; Stahl, schwarz / Textilfaden, natur  
luminaire en suspension; acier, noir / fil textile, nature

L 900, B 200, H 1100



E27



3x 40W



9 002759 437862





43775



43777



43776



### 43775 ADWICKLE

ceiling light; steel, black / fabric, natural  
Deckenleuchte; Stahl, schwarz / Textil, natur  
plafonnier; acier, noir / tissu, nature

H 260, Ø 445



E27

1x 40W



9 002759 437756

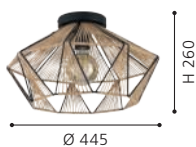

H 260

Ø 445

### 43777 ADWICKLE

pendant light; steel, black / fabric, natural  
Hängeleuchte; Stahl, schwarz / Textil, natur  
luminaire en suspension; acier, noir / tissu, nature

L 870, B 145, H 1100



E27

3x 40W



9 002759 437770



H 1100

L 870

### 43776 ADWICKLE

pendant light; steel, black / fabric, natural  
Hängeleuchte; Stahl, schwarz / Textil, natur  
luminaire en suspension; acier, noir / tissu, nature

L 170, B 145, H 1100



E27

1x 40W



9 002759 437763

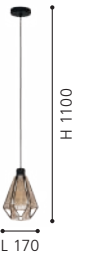

H 1100

L 170

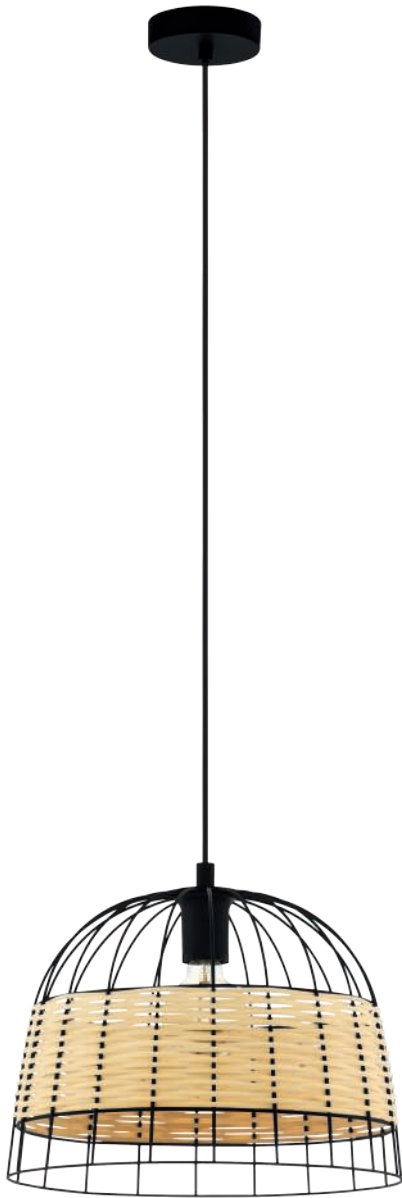

43311



43313

### 43311 ANWICK

pendant light; steel, black / rattan, natural  
 Hängeleuchte; Stahl, schwarz / Rattan, natur  
 luminaire en suspension; acier, noir / rotin, nature

H 1100, Ø 370



E27 1x 40W



9 002759 433116



### 43313 ANWICK

pendant light; steel, black / rattan, natural  
 Hängeleuchte; Stahl, schwarz / Rattan, natur  
 luminaire en suspension; acier, noir / rotin, nature

L 880, B 180, H 1100



E27 3x 40W



9 002759 433130





43398



43312



### 43398 ANWICK

ceiling light; steel, black / rattan, natural  
Deckenleuchte; Stahl, schwarz / Rattan, natur  
plafonnier; acier, noir / rotin, nature

H 265, Ø 380



E27



1x 60W



9 002759 433987

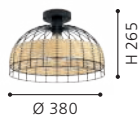

### 43312 ANWICK

pendant light; steel, black / rattan, natural  
Hängeleuchte; Stahl, schwarz / Rattan, natur  
luminaire en suspension; acier, noir / rotin, nature

H 1100, Ø 500



E27



1x 40W



9 002759 433123





### 43325 ANWICK 1

spot; steel, black / rattan, natural  
 Spot; Stahl, schwarz / Rattan, natur  
 spot; acier, noir / rotin, nature

L 480, B 140, H 240



E27



2x 40W



9 002759 433253

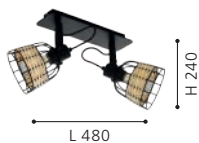

### 43326 ANWICK 1

spot; steel, black / rattan, natural  
 Spot; Stahl, schwarz / Rattan, natur  
 spot; acier, noir / rotin, nature

L 670, B 140, H 240



E27



3x 40W



9 002759 433260



### 43324 ANWICK 1

spot; steel, black / rattan, natural  
 Spot; Stahl, schwarz / Rattan, natur  
 spot; acier, noir / rotin, nature

L 140, H 200



E27



1x 40W



9 002759 433246

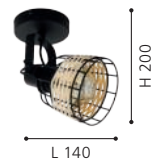





43324





43851



43854



43853

### 43851 HYKEHAM

ceiling light; steel, black / wood, natural  
Deckenleuchte; Stahl, schwarz / Holz, natur  
plafonnier; acier, noir / bois, nature

H 210, Ø 380



E27 1x 40W



9 002759 438517

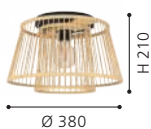

### 43854 HYKEHAM

table light; steel, black / wood, natural  
Tischleuchte; Stahl, schwarz / Holz, natur  
luminaire de table; acier, noir / bois, nature

H 570, Ø 210, Base: Ø 285



E27 1x 40W



9 002759 438548



### 43853 HYKEHAM

pendant light; steel, black / wood, natural  
Hängeleuchte; Stahl, schwarz / Holz, natur  
luminaire en suspension; acier, noir / bois, nature

L 910, B 210, H 1100



E27 3x 40W



9 002759 438531





43855



43852

### 43855 HYKEHAM

floor light; steel, black / wood, natural  
 Stehleuchte; Stahl, schwarz / Holz, natur  
 lampadaire; acier, noir / bois, nature

H 1295, Ø 380, Base: Ø 630



E27



1x 40W



9 002759 438555

### 43852 HYKEHAM

pendant light; steel, black / wood, natural  
 Hängeleuchte; Stahl, schwarz / Holz, natur  
 luminaire en suspension; acier, noir / bois, nature

H 1100, Ø 380



E27



1x 40W



9 002759 438524



43216



43231



43218

### 43216 BORDESLEY

pendant light; steel, black / wood, natural  
Hängeleuchte; Stahl, schwarz / Holz, natur  
luminaire en suspension; acier, noir / bois, nature

H 1100, Ø 350



E27 1x 28W



9 002759 432164



### 43231 BORDESLEY

pendant light; steel, black / wood, natural  
Hängeleuchte; Stahl, schwarz / Holz, natur  
luminaire en suspension; acier, noir / bois, nature

H 1100, Ø 210



E27 1x 28W



9 002759 432317



### 43218 BORDESLEY

table light; steel, black / wood, natural  
Tischleuchte; Stahl, schwarz / Holz, natur  
luminaire de table; acier, noir / bois, nature

H 400, Ø 210, Base: Ø 190



E27 1x 28W



9 002759 432188





43217

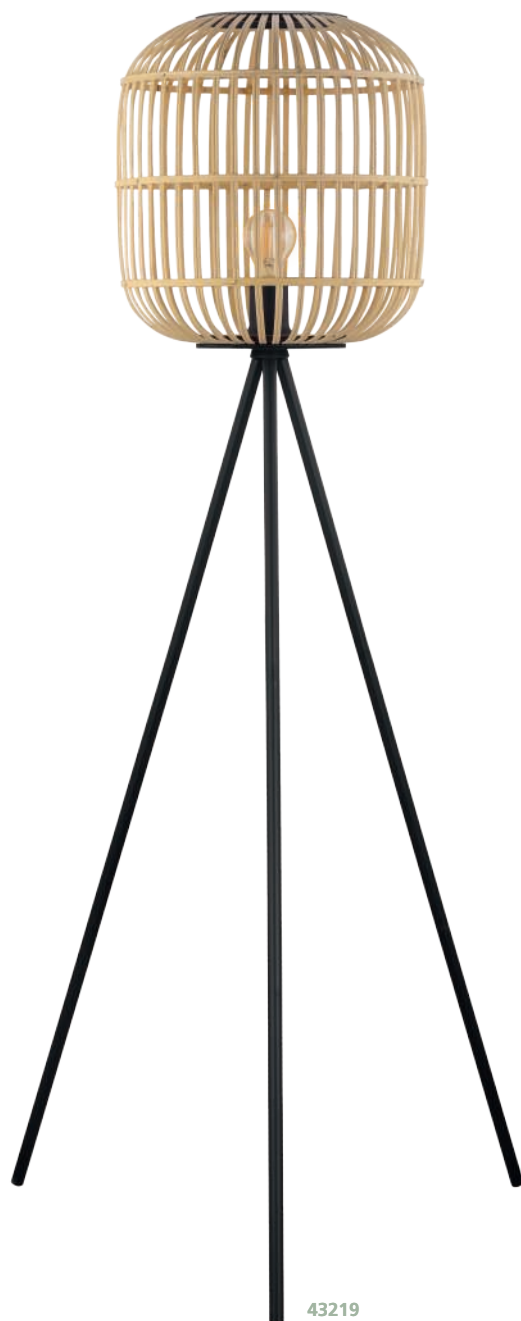

43219

### 43217 BORDESLEY

pendant light; steel, black / wood, natural  
 Hängeleuchte; Stahl, schwarz / Holz, natur  
 luminaire en suspension; acier, noir / bois, nature

L 910, B 210, H 1100



E27



3x 28W



9 002759 432171

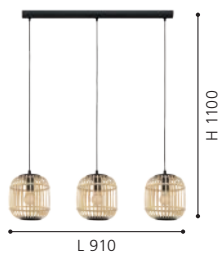

### 43219 BORDESLEY

floor light; steel, black / wood, natural  
 Stehleuchte; Stahl, schwarz / Holz, natur  
 lampadaire; acier, noir / bois, nature

H 1390, Ø 350, Base: Ø 820



E27



1x 28W



9 002759 432195





43872

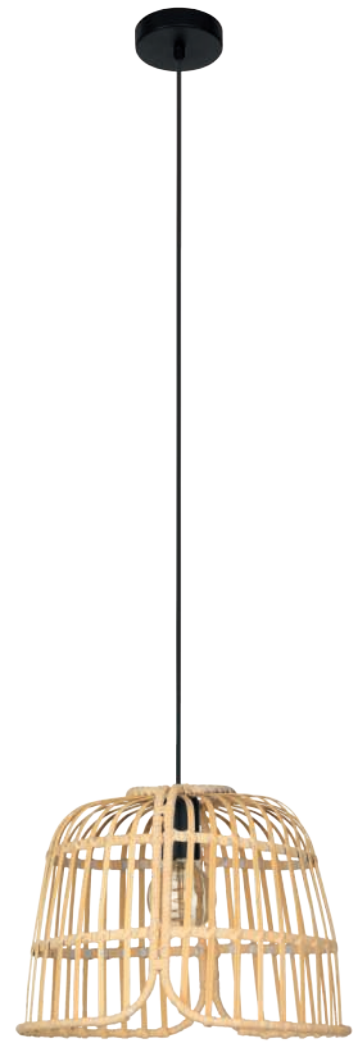

43873

### 43872 GLYNEATH

ceiling light; steel, black / wood, natural  
Deckenleuchte; Stahl, schwarz / Holz, natur  
plafonnier; acier, noir / bois, nature

H 205, Ø 375



E27



1x 40W



9 002759 438722



### 43873 GLYNEATH

pendant light; steel, black / wood, natural  
Hängeleuchte; Stahl, schwarz / Holz, natur  
luminaire en suspension; acier, noir / bois, nature

H 1100, Ø 375



E27



1x 40W



9 002759 438739

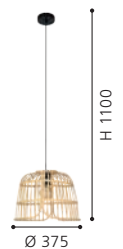



43831



43285

### 43831 AUSNBY

ceiling light; steel, black / wood, natural  
 Deckenleuchte; Stahl, schwarz / Holz, natur  
 plafonnier; acier, noir / bois, nature

H 200, Ø 370



E27



1x 40W



9 002759 438319

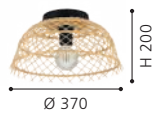

### 43285 AUSNBY

pendant light; steel, black / wood, natural  
 Hängeleuchte; Stahl, schwarz / Holz, natur  
 luminaire en suspension; acier, noir / bois, nature

H 1100, Ø 370



E27



1x 40W



9 002759 432850





43266

### 43266 DEMBLEBY 1

pendant light; steel, black / wood, black  
 Hängeleuchte; Stahl, schwarz / Holz, schwarz  
 luminaire en suspension; acier, noir / bois, noir

L 900, B 200, H 1100



E27



3x 40W



9 002759 432669

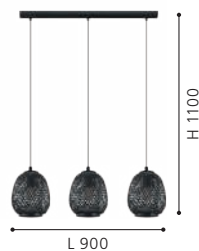

### 43265 DEMBLEBY 1

pendant light; steel, black / wood, black  
 Hängeleuchte; Stahl, schwarz / Holz, schwarz  
 luminaire en suspension; acier, noir / bois, noir

H 1100, Ø 320



E27



1x 40W



9 002759 432652







43265





43262



43263

### 43262 DEMBLEBY

pendant light; steel, black / wood, natural  
 Hängeleuchte; Stahl, schwarz / Holz, natur  
 luminaire en suspension; acier, noir / bois, nature

L 900, B 200, H 1100



E27



3x 40W



9 002759 432621



### 43263 DEMBLEBY

table light; steel, black / wood, natural  
 Tischleuchte; Stahl, schwarz / Holz, natur  
 luminaire de table; acier, noir / bois, nature

H 250, Ø 200, Base: Ø 115



E27



1x 40W



9 002759 432638



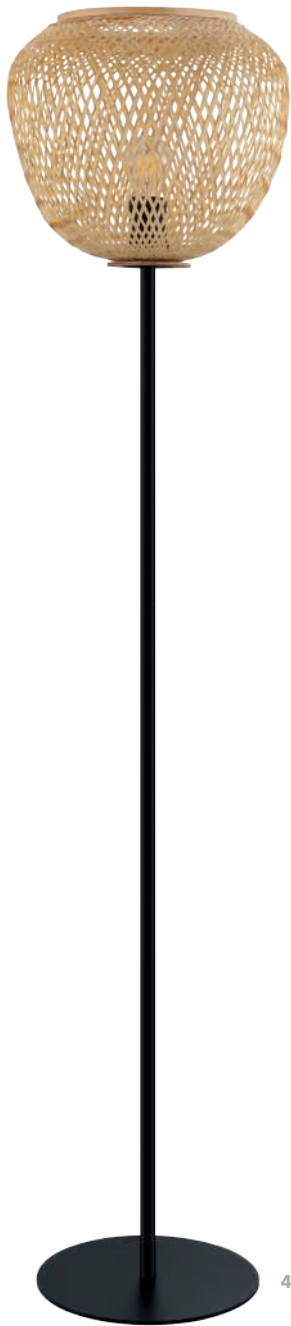

43264



43261

### 43264 DEMBLEBY

floor light; steel, black / wood, natural  
 Stehleuchte; Stahl, schwarz / Holz, natur  
 lampadaire; acier, noir / bois, nature

H 1500, Ø 320, Base: Ø 275



E27



1x 40W



Ø 320



H 1500

Ø 275



9 002759 432645

### 43261 DEMBLEBY

pendant light; steel, black / wood, natural  
 Hängeleuchte; Stahl, schwarz / Holz, natur  
 luminaire en suspension; acier, noir / bois, nature

H 1100, Ø 320



E27



1x 40W



H 1100

Ø 320



9 002759 432614



43253



43252

43254

### 43253 CLAVERDON

pendant light; steel, black / wood, natural  
Hängeleuchte; Stahl, schwarz / Holz, natur  
luminaire en suspension; acier, noir / bois, nature

H 1100, Ø 370



E27 1x 40W



9 002759 432539



### 43254 CLAVERDON

pendant light; steel, black / wood, natural  
Hängeleuchte; Stahl, schwarz / Holz, natur  
luminaire en suspension; acier, noir / bois, nature

H 1100, Ø 495



E27 1x 40W



9 002759 432546



### 43252 CLAVERDON

pendant light; steel, black / wood, natural  
Hängeleuchte; Stahl, schwarz / Holz, natur  
luminaire en suspension; acier, noir / bois, nature

H 1100, Ø 180



E27 1x 40W



9 002759 432522





43255



43251

#### DETAIL 43255

The luminaire heads can be installed on the ceiling individually.  
Die Leuchtenköpfe können individuell an die Decke montiert werden.  
Les têtes de luminaires peuvent être montées individuellement au plafond.

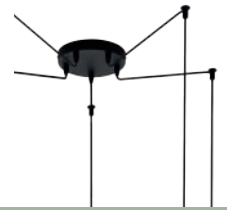

#### 43255 CLAVERDON

pendant light; steel, black / wood, natural  
Hängeleuchte; Stahl, schwarz / Holz, natur  
luminaire en suspension; acier, noir / bois, nature

H 2000, Ø 180



E27



5x 40W



9 002759 432553



H 2000

#### 43251 CLAVERDON

ceiling light; steel, black / wood, natural  
Deckenleuchte; Stahl, schwarz / Holz, natur  
plafonnier; acier, noir / bois, nature

H 245, Ø 370



E27



1x 40W



9 002759 432515



H 245

Ø 370



43866



43867

### 43866 AYESGARTH

pendant light; steel, black / wood, natural  
 Hängeleuchte; Stahl, schwarz / Holz, natur  
 luminaire en suspension; acier, noir / bois, nature

H 1100, Ø 330



E27



1x 40W



9 002759 438661



### 43867 AYESGARTH

pendant light; steel, black / wood, natural  
 Hängeleuchte; Stahl, schwarz / Holz, natur  
 luminaire en suspension; acier, noir / bois, nature

L 910, B 210, H 1100



E27



3x 40W



9 002759 438678





49772



43723



49771

### 49772 AMSFIELD

pendant light; steel, brown / wood, brown  
Hängeleuchte; Stahl, braun / Holz, braun  
luminaire en suspension; acier, marron / bois, marron

H 1100, Ø 350



E27



1x 60W



9 002759 497729



### 43723 AMSFIELD

ceiling light; steel, black / wood, brown  
Deckenleuchte; Stahl, schwarz / Holz, braun  
plafonnier; acier, noir / bois, marron

H 285, Ø 450



E27



1x 40W



9 002759 437237

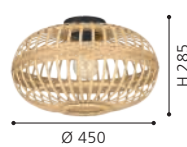

### 49771 AMSFIELD

pendant light; steel, brown / wood, brown  
Hängeleuchte; Stahl, braun / Holz, braun  
luminaire en suspension; acier, marron / bois, marron

H 1100, Ø 380



E27



1x 60W



9 002759 497712





43113

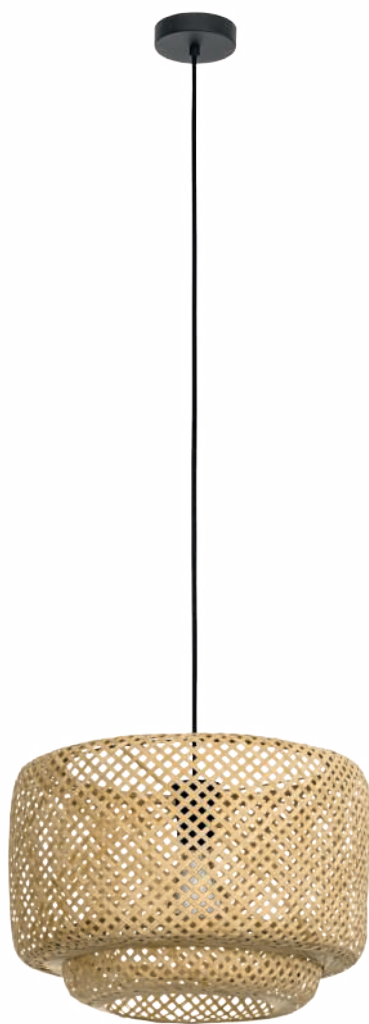

43868

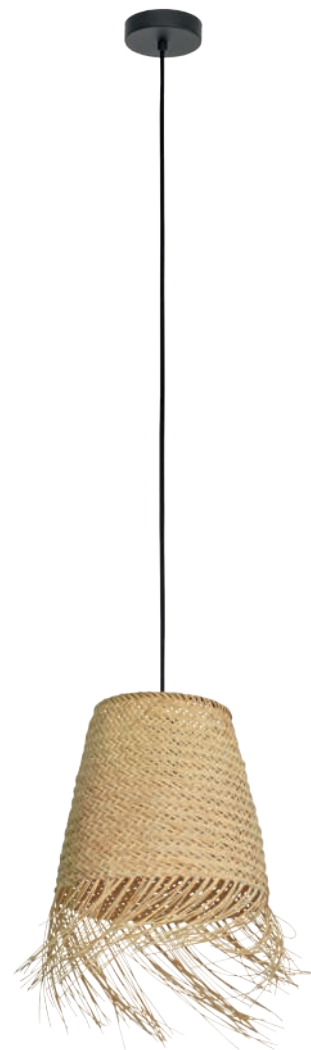

43871

### 43113 KIRKCOLM

pendant light; steel, satin nickel / wood, natural  
Hängeleuchte; Stahl, nickel-matt / Holz, natur  
luminaire en suspension; acier, nickel mat / bois, nature

H 1100, Ø 300



E27 1x 60W



9 002759 431136



### 43868 HETTONLE

pendant light; steel, black / wood, natural  
Hängeleuchte; Stahl, schwarz / Holz, natur  
luminaire en suspension; acier, noir / bois, nature

H 1100, Ø 420



E27 1x 40W



9 002759 438685

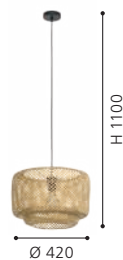

### 43871 AYCLIFFE

pendant light; steel, black / wood, natural  
Hängeleuchte; Stahl, schwarz / Holz, natur  
luminaire en suspension; acier, noir / bois, nature

H 1100, Ø 300



E27 1x 40W



9 002759 438715





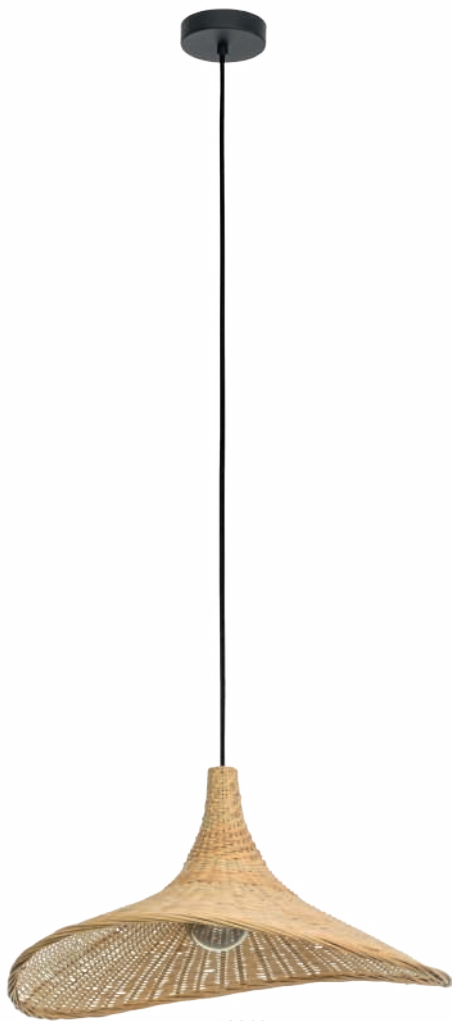

43869



43874

### 43869 HAXEY

pendant light; steel, black / wood, natural  
 Hängeleuchte; Stahl, schwarz / Holz, natur  
 luminaire en suspension; acier, noir / bois, nature

H 1100, Ø 500



E27



1x 40W



9 002759 438692

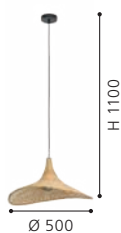

### 43874 SURFLEET

pendant light; steel, wood, black, brown / fabric, linen, natural  
 Hängeleuchte; Stahl, Holz, schwarz, braun / Textil, Leinen, natur  
 luminaire en suspension; acier, bois, noir, marron / tissu, lin, nature

H 1100, Ø 330



E27



1x 40W



9 002759 438746



# COTTAGE CHIC

It's tea o'clock – the famous tea time shouldn't be limited to Brits. Interrupt the rhythm of your day, take a deep breath and enjoy a few moments of calm. It will feel so good! Best do it with a cup of tea in a British-style atmosphere, glass, crystal, flower patterns and luminaires that are presented as decorative pieces. EGLO will bring a piece of British Cottage Chic to your home without having to travel at all.

It's tea o'clock – die berühmte Teepause sollten sich nicht nur die Briten gönnen. Unterbrechen Sie Ihren Tagesrhythmus, atmen Sie tief durch und genießen Sie ein paar Momente der Stille. Wie gut das tut! Am besten in britisch angehauchter Atmosphäre mit einer Tasse Tee in der Hand. Keramik, Glas, Kristall, Blümchendekor und Leuchten, die sich als Dekostücke präsentieren. Ohne Reisen erhalten Sie mit EGLO ein Stück britischen Cottage Chics für Ihr Zuhause.

It's tea o'clock (Il est l'heure du thé) – la célèbre pause thé ne doit pas uniquement être destiné aux britanniques. Interrompez votre rythme quotidien, respirez profondément et régalez-vous de quelques instants de silence. Combien de bien cela peut faire ! Le mieux serait de faire cela dans une atmosphère à inspiration britannique, ayant une tasse de thé à la main. De la céramique, du verre, du Crystal, des décorations à fleurs et des luminaires, se présentant en tant que pièces décoratives. Grâce à EGLO, vous obtenez un peu de Cottage Chics britannique pour votre maison, sans même devoir voyager.





EDALE  
p. 242



ARNHEM  
p. 244-245, 246



MEDIOUNA  
p. 246



BRADFORD  
p. 248-249



BRADFORD 1  
p. 249



KENSAL  
p. 250



NIMLET  
p. 251



KINROSS  
p. 252



HAMBLETON  
p. 252



CAPOSILE  
p. 252



TOWNSHEND 2  
p. 253



This product is available in different colors and shapes./ Dieser Artikel ist in unterschiedlichen Farben und Formen verfügbar.  
Cet article est disponible en différentes couleurs et formes.



43783



43782



### 43783 EDALE

wall light; steel, wood, black, brown / fabric, cappuccino  
Wandleuchte; Stahl, Holz, schwarz, braun / Textil, cappuccino  
applique; acier, bois, noir, marron / tissu, cappuccino

L 150, H 215, A 195



E27



1x 40W



9 002759 437831



### 43782 EDALE

pendant light; steel, wood, black, brown / fabric, cappuccino  
Hängeleuchte; Stahl, Holz, schwarz, braun / Textil, cappuccino  
luminaire en suspension; acier, bois, noir, marron / tissu, cappuccino

L 1080, B 510, H 1100



E27



6x 40W



9 002759 437824



### 43781 EDALE

pendant light; steel, wood, black, brown / fabric, cappuccino  
Hängeleuchte; Stahl, Holz, schwarz, braun / Textil, cappuccino  
luminaire en suspension; acier, bois, noir, marron / tissu, cappuccino

H 1100, Ø 700



E27



6x 40W



9 002759 437817

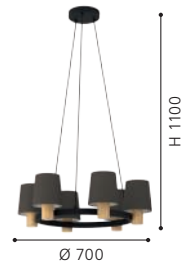



43781





43401



43402



**DETAIL 43403**

The luminaire heads can be installed on the ceiling individually.  
Die Leuchtenköpfe können individuell an die Decke montiert werden.  
Les têtes de luminaires peuvent être montées individuellement au plafond.

**43401 ARNHEM**

pendant light; steel, white / paper, seagrass, white, brown  
Hängeleuchte; Stahl, weiss / Papier, Seegrass, weiss, braun  
luminaire en suspension; acier, blanc / papier, en jonc de mer, blanc, marron

H 1100, Ø 240



E27 1x 40W



9 002759 434014



**43402 ARNHEM**

pendant light; steel, white / paper, seagrass, white, brown  
Hängeleuchte; Stahl, weiss / Papier, Seegrass, weiss, braun  
luminaire en suspension; acier, blanc / papier, en jonc de mer, blanc, marron

L 1020, B 240, H 1100



E27 3x 40W



9 002759 434021



**43403 ARNHEM**

pendant light; steel, white / paper, seagrass, white, brown  
Hängeleuchte; Stahl, weiss / Papier, Seegrass, weiss, braun  
luminaire en suspension; acier, blanc / papier, en jonc de mer, blanc, marron

H 1300, Ø 960



E27 3x 40W



9 002759 434038





43403



43555



43556

### 43555 ARNHEM

table light; steel, white / paper, seagrass, white, brown  
Tischleuchte; Stahl, weiss / Papier, Seegrass, weiss, braun  
luminaire de table; acier, blanc / papier, en jonc de mer, blanc, marron

H 610, Ø 240, Base: Ø 290



E27 1x 40W



9 002759 435554

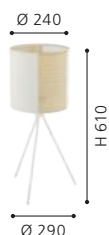

### 43556 ARNHEM

floor light; steel, white / paper, seagrass, white, brown  
Stehleuchte; Stahl, weiss / Papier, Seegrass, weiss, braun  
lampadaire; acier, blanc / papier, en jonc de mer, blanc, marron

H 1510, Ø 440, Base: Ø 750



E27 1x 40W



9 002759 435561



### 43393 MEDIOUNA

pendant light; steel, beige / glass vaporized, seagrass, gold color, brown

Hängeleuchte; Stahl, beige / Glas bedampft, Seegrass, goldfarben, braun

luminaire en suspension; acier, beige / verre vaporisé, en jonc de mer, doré, marron

H 1100, Ø 230



E27 1x 40W



9 002759 433932

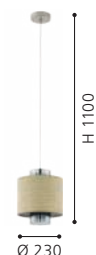





43393



49214



49284



49213

### 49214 BRADFORD

pendant light; steel, silver-antique / glass, clear  
Hängeleuchte; Stahl, silber-antik / Glas, klar  
luminaire en suspension; acier, argent antique / verre, transparent

H 1100, Ø 140



E27 1x 60W



9 002759 492144

### 49284 BRADFORD

table light; steel, silver-antique / glass, clear  
Tischleuchte; Stahl, silber-antik / Glas, klar  
luminaire de table; acier, argent antique / verre, transparent

H 330, Ø 140



E27 1x 60W



9 002759 492847

### 49213 BRADFORD

pendant light; steel, black / glass, clear  
Hängeleuchte; Stahl, schwarz / Glas, klar  
luminaire en suspension; acier, noir / verre, transparent

H 1100, Ø 140



E27 1x 60W



9 002759 492137



49283



43624



43623

### 49283 BRADFORD

table light; steel, black / glass, clear  
Tischleuchte; Stahl, schwarz / Glas, klar  
luminaire de table; acier, noir / verre, transparent

H 330, Ø 140



E27 1x 60W



9 002759 492830



### 43624 BRADFORD 1

table light; steel, black / glass, clear  
Tischleuchte; Stahl, schwarz / Glas, klar  
luminaire de table; acier, noir / verre, transparent

L 150, B 150, H 405

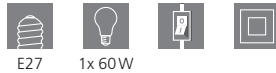

E27 1x 60W



9 002759 436247



### 43623 BRADFORD 1

table light; steel, black / glass, clear  
Tischleuchte; Stahl, schwarz / Glas, klar  
luminaire de table; acier, noir / verre, transparent

L 165, B 150, H 370



E27 1x 60W



9 002759 436230





43642

### 43642 KENSAL

table light; steel, grey, black / fabric, black  
Tischleuchte; Stahl, grau, schwarz / Textil, schwarz  
luminaire de table; acier, gris, noir / tissu, noir

H 435, Ø 250, Base: Ø 140



E27



1x 40W



9 002759 436421





43653



43652

### 43653 NIMLET

table light; steel, black / fabric, black  
Tischleuchte; Stahl, schwarz / Textil, schwarz  
luminaire de table; acier, noir / tissu, noir

H 515, Ø 300, Base: Ø 135



E27



1x 40W



9 002759 436537



### 43652 NIMLET

table light; steel, black / fabric, white  
Tischleuchte; Stahl, schwarz / Textil, weiss  
luminaire de table; acier, noir / tissu, blanc

H 515, Ø 300, Base: Ø 135



E27



1x 40W



9 002759 436520





49724



49489



49851

### 49724 KINROSS

pendant light; steel, brown / wood, brown  
Hängeleuchte; Stahl, braun / Holz, braun  
luminaire en suspension; acier, marron / bois, marron

H 1100, Ø 310



E27 1x 60W



9 002759 497248



### 49489 HAMBLETON

pendant light; steel, satin nickel / steel, white  
Hängeleuchte; Stahl, nickel-matt / Stahl, weiss  
luminaire en suspension; acier, nickel mat / acier, blanc

H 1100, Ø 350



E27 1x 60W



9 002759 494896



### 49851 CAPOSILE

pendant light; steel, white  
Hängeleuchte; Stahl, weiss  
luminaire en suspension; acier, blanc

H 1100, Ø 545

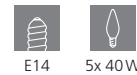

E14 5x 40W



9 002759 498511

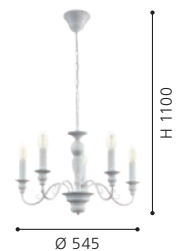



49927

### 49927 TOWNSHEND 2

pendant light; steel, wood, white-patina / fabric, linen, white, brown

Hängeleuchte; Stahl, Holz, weiss-patina / Textil, Leinen, weiss, braun

luminaire en suspension; acier, bois, blanc patiné / tissu, lin, blanc, marron

L 1000, B 150, H 1100



E27



4x 60W



9 002759 499273



# ETHNO ELEGANCE

A little Orient, a bit of Africa, a touch of Latin America – but nothing common at all! These lamps let you dive into a world of exotic markets with spices, colours and shapes. Bring fairy-tale moments from remote countries to your home – with Ethno Elegance.

Ein bisschen Orient, ein wenig Afrika, ein Hauch Lateinamerika – nur nichts Gewöhnliches! Mit diesen Leuchten tauchen Sie ein in eine Welt exotischer Märkte mit Gewürzen, Farben und Formen. Holen Sie märchenhafte Momente aus fernen Ländern zu sich nach Hause – mit Ethno Elegance.

Un peu oriental, un peu africain, une touche d'Amérique latine – surtout rien d'ordinaire ! Grâce à ces luminaires, vous entrez dans un monde de marchés exotiques avec des épices, des couleurs et des formes. Apportez des moments féériques dans votre maison, venant de pays lointains – grâce à Ethno Elegance.







**BRIDEKIRK**  
p. 256



**COULSDON**  
p. 256



**STAVERTON**  
p. 257



**SAFI**  
p. 258



**MELILLA**  
p. 260



**TALBOT 2**  
p. 260



**TAMALLAT**  
p. 261



**STEELEVILLE**  
p. 263



**JADIDA**  
p. 263



**CARDIGAN**  
p. 264



**SUDBURY**  
p. 265



**TALBOT**  
p. 265



This product is available in different colors and shapes./ Dieser Artikel ist in unterschiedlichen Farben und Formen verfügbar.  
Cet article est disponible en différentes couleurs et formes.



43292



43314

### 43292 BRIDEKIRK

pendant light; steel, black / fabric, linen, natural  
Hängeleuchte; Stahl, schwarz / Textil, Leinen, natur  
luminaire en suspension; acier, noir / tissu, lin, nature

H 1100, Ø 400



E27



1x 40W



9 002759 432928



### 43314 COULSDON

pendant light; steel, black / film, black, white  
Hängeleuchte; Stahl, schwarz / Folie, schwarz, weiss  
luminaire en suspension; acier, noir / film, noir, blanc

H 1310, Ø 145



E27



5x 10W



9 002759 433147

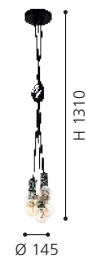



32469



43344



#### DETAIL 43314

The luminaire heads can be installed in 2 ways on the ceiling.  
Die Leuchtenköpfe können auf 2 Arten an die Decke montiert werden.  
Les têtes de luminaire peuvent être montées de 2 manières au plafond.

#### 32469 STAVERTON

ceiling light; steel, black  
Deckenleuchte; Stahl, schwarz  
plafonnier; acier, noir

H 250, Ø 365



E27



1x 60W



9 002759 324698

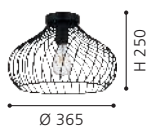

#### 43344 STAVERTON

pendant light; steel, black  
Hängeleuchte; Stahl, schwarz  
luminaire en suspension; acier, noir

H 1100, Ø 365



E27



1x 60W



9 002759 433444

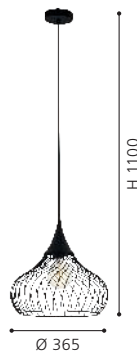



49815



49871

### 49815 SAFI

pendant light; steel, brown, gold  
 Hängeleuchte; Stahl, braun, gold  
 luminaire en suspension; acier, marron, or

H 2000, Ø 405



E27 1x 60W



9 002759 498153



### 49871 SAFI

pendant light; steel, brown, gold  
 Hängeleuchte; Stahl, braun, gold  
 luminaire en suspension; acier, marron, or

L 700, B 160, H 1100



E27 3x 60W



9 002759 498719



### 49814 SAFI

pendant light; steel, brown, gold  
 Hängeleuchte; Stahl, braun, gold  
 luminaire en suspension; acier, marron, or

H 1100, Ø 275



E27 1x 60W



9 002759 498146





49814



49768

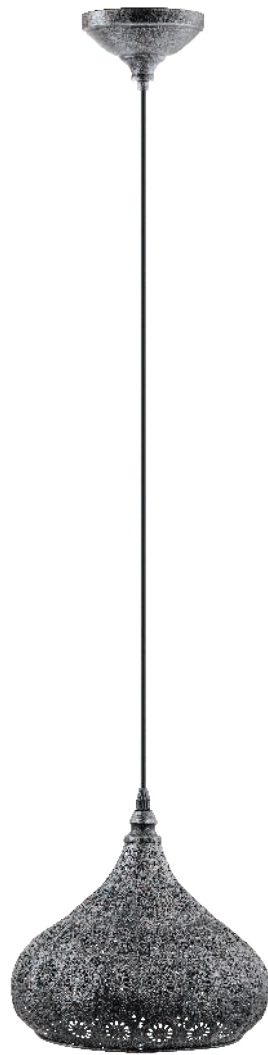

49714

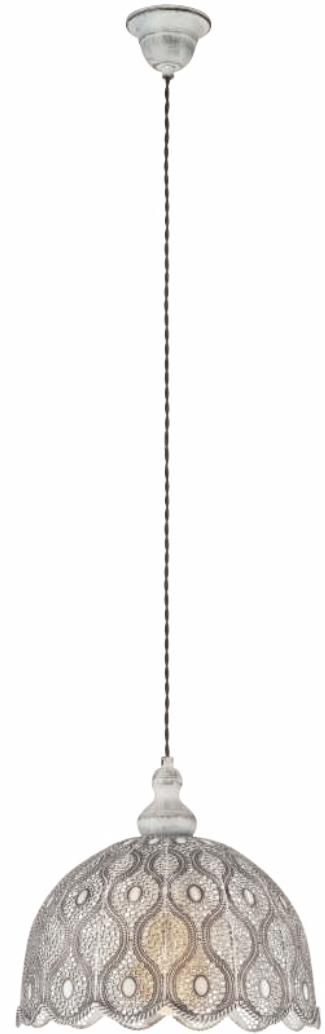

49717

### 49768 MELILLA

pendant light; steel, gold  
Hängeleuchte; Stahl, gold  
luminaire en suspension; acier, or

H 1100, Ø 330



E27



1x 60W



9 002759 497682



### 49714 MELILLA

pendant light; steel, silver-antique  
Hängeleuchte; Stahl, silber-antik  
luminaire en suspension; acier, argent antique

H 1100, Ø 285



E27



1x 60W



9 002759 497149

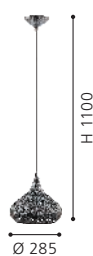

### 49717 TALBOT 2

pendant light; steel, white-antique  
Hängeleuchte; Stahl, weiss-antik  
luminaire en suspension; acier, blanc antique

H 1100, Ø 295



E27



1x 60W



9 002759 497170



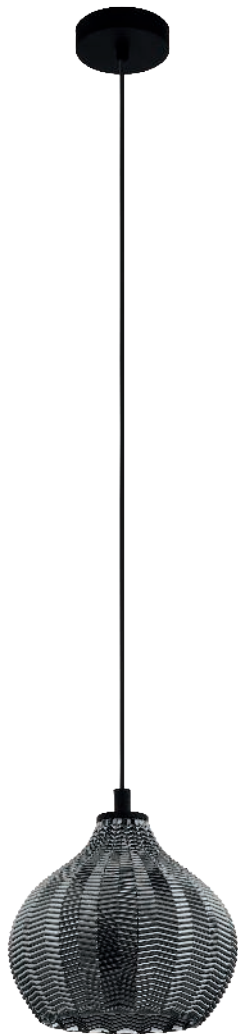

43576



43577

### 43576 TAMALLAT

pendant light; steel, black / glass vaporized, black-transparent  
 Hängeleuchte; Stahl, schwarz / Glas bedampft, schwarz-transparent  
 luminaire en suspension; acier, noir / verre vaporisé, noir transparent

H 1100, Ø 230



E27



1x 40W



9 002759 435769



### 43577 TAMALLAT

pendant light; steel, black / glass vaporized, black-transparent  
 Hängeleuchte; Stahl, schwarz / Glas bedampft, schwarz-transparent  
 luminaire en suspension; acier, noir / verre vaporisé, noir transparent

L 1050, B 230, H 1100



E27



3x 40W



9 002759 435776



DESIGN  
HIGHLIGHT  
DETAIL





43587





49764



49765

### 43587 STEELEVILLE

pendant light; steel, brown-patina, white / crystal glass, black-transparent

Hängeleuchte; Stahl, braun-patina, weiss / Kristallglas, schwarz-transparent

luminaire en suspension; acier, marron patiné, blanc / verre cristal, noir transparent

H 1200, Ø 410



E27



1x 40W



9 002759 435875



### 49764 JADIDA

pendant light; steel, copper-coloured antique / glass, coloured

Hängeleuchte; Stahl, kupferfarben-antik / Glas, bunt

luminaire en suspension; acier, cuivré antique / verre, coloré

H 1100, Ø 330



E27



1x 60W



9 002759 497644

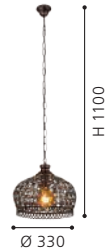

### 49765 JADIDA

pendant light; steel, copper-coloured antique / glass, coloured

Hängeleuchte; Stahl, kupferfarben-antik / Glas, bunt

luminaire en suspension; acier, cuivré antique / verre, coloré

H 1100, Ø 220



E27



1x 60W



9 002759 497651

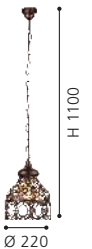



49201



49202



49274

### 49201 CARDIGAN

pendant light; steel, brown-patina / glass, clear  
Hängeleuchte; Stahl, braun-patina / Glas, klar  
luminaire en suspension; acier, marron patiné / verre, transparent

H 1100, Ø 120



E27



1x 60W



9 002759 492014



### 49202 CARDIGAN

pendant light; steel, grey-blue / glass, clear  
Hängeleuchte; Stahl, grau-blau / Glas, klar  
luminaire en suspension; acier, gris-bleu / verre, transparent

H 1100, Ø 120



E27



1x 60W



9 002759 492021

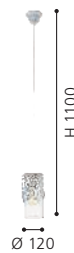

### 49274 CARDIGAN

table light; steel, brown-patina / glass, clear  
Tischleuchte; Stahl, braun-patina / Glas, klar  
luminaire de table; acier, marron patiné / verre, transparent

H 265, Ø 120



E27



1x 60W



9 002759 492748



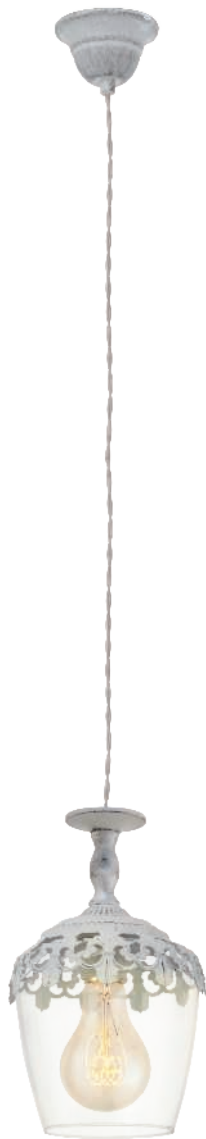

49221



49276

### 49221 SUDBURY

pendant light; steel, white-patina / glass, clear  
 Hängeleuchte; Stahl, weiss-patina / Glas, klar  
 luminaire en suspension; acier, blanc patiné / verre, transparent

H 1100, Ø 170



E27



1x 60W



9 1002759 492212

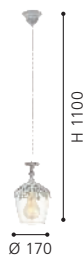

### 49276 TALBOT

table light; steel, black-patina  
 Tischleuchte; Stahl, schwarz-patina  
 luminaire de table; acier, noir patiné

H 340, Ø 170



E27



1x 60W



9 1002759 492762



# SOCKETS

Minimalism at its best! The SOCKET series by EGLO comes in a variety of styles: from a discreet brass ring attachment to a gritty industrial finish. The most important thing is to choose the best light source to skilfully present the luminaire in its best light.

Minimalismus pur! So präsentiert sich die SOCKET-Serie von EGLO in verschiedenen Stilen: Ob mit dezentem Messingring oder grober Industrial-Haptik. Wichtig bleibt dabei die Wahl des richtigen Leuchtmittels, um die Fassung gekonnt in Szene zu setzen.

Le minimalisme à l'état pur ! Voici comment se présente la série SOCKET d'EGLO dans différents styles : avec un discret anneau en laiton ou une structure rugueuse à l'esprit industriel. L'essentiel est de bien choisir l'ampoule afin de mettre habilement la douille en valeur.





**CRANLEY**  
p. 268



**YORTH**  
p. 269, 271



**CALARI**  
p. 270



This product is available in different colors and shapes./ Dieser Artikel ist in unterschiedlichen Farben und Formen verfügbar.  
Cet article est disponible en différentes couleurs et formes.



DESIGN  
HIGHLIGHT  
DETAIL

### 43758 CRANLEY

floor light; steel, black  
Stehleuchte; Stahl, schwarz  
lampadaire; acier, noir

L 430, B 60, H 1700, Base: Ø 300



E27



1x 40W



9 002759 437589

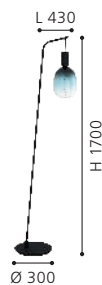

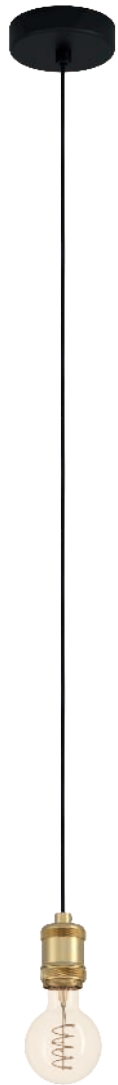

43803



43802



43801



DESIGN  
HIGHLIGHT  
DETAIL

### 43803 YORTH

pendant light; steel, black, bronzed  
Hängeleuchte; Stahl, schwarz, brüniert  
luminaire en suspension; acier, noir, brun

H 1500, Ø 50



E27



1x 40W



9 002759 438036



### 43802 YORTH

pendant light; steel, black, silver  
Hängeleuchte; Stahl, schwarz, silber  
luminaire en suspension; acier, noir, argent

H 1500, Ø 50



E27



1x 40W



9 002759 438029



### 43801 YORTH

pendant light; steel, nickel-nero, black  
Hängeleuchte; Stahl, nickel-nero, schwarz  
luminaire en suspension; acier, nickel brillant, noir

H 1500, Ø 50



E27



1x 40W



9 002759 438012





31075



31073

### 31075 CALARI

pendant light; steel, black, brass  
Hängeleuchte; Stahl, schwarz, messing  
luminaire en suspension; acier, noir, laiton

H 1500, Ø 45



E27



1x 40W



9 002759 310752



### 31073 CALARI

pendant light; steel, black  
Hängeleuchte; Stahl, schwarz  
luminaire en suspension; acier, noir

L 95, B 65, H 1500



E27



1x 40W



9 002759 310738







32522



32539



32531

### 32522 YORTH

pendant light; steel, satin nickel  
Hängeleuchte; Stahl, nickel-matt  
luminaire en suspension; acier, nickel mat

H 2000, Ø 100



E27



1x 60W



9 002759 325220



### 32539 YORTH

pendant light; steel, brushed copper  
Hängeleuchte; Stahl, kupfer-gebürstet  
luminaire en suspension; acier, cuivre brossé

H 2000, Ø 100



E27



1x 60W



9 002759 325398



### 32531 YORTH

pendant light; steel, grey  
Hängeleuchte; Stahl, grau  
luminaire en suspension; acier, gris

H 2000, Ø 110



E27



1x 60W



9 002759 325312



# ILLUMINANTS





<b>110098</b> p. 274	<b>11099</b> p. 275	<b>110101</b> p. 275	<b>110095</b> p. 276	<b>110096</b> p. 276	<b>110097</b> p. 277	<b>110109</b> p. 278	<b>110111</b> p. 278
							
<b>110112</b> p. 279	<b>11898</b> p. 280	<b>11899</b> p. 280	<b>11901</b> p. 281	<b>11902</b> p. 281	<b>12591</b> p. 282	<b>12592</b> p. 282	<b>12593</b> p. 283
							
<b>11836</b> p. 284	<b>11837</b> p. 284	<b>12594</b> p. 285	<b>12596</b> p. 285	<b>12586</b> p. 286	<b>12584</b> p. 286	<b>12585</b> p. 287	
							



# BIG SIZE

- › extra large shape, modern colors and surfaces
- › straight and spiral filaments
- › the eye-catcher in your living area
- › energy-saving LED filament technology

- › extra große Form, moderne Farben und Oberflächen
- › gerade und spiralförmige Filamente
- › der Blickfang in Ihrem Wohnbereich
- › energiesparende LED Filamenttechnologie

- › Forme extra large, couleurs et surfaces modernes
- › filaments droits et spiralés
- › Attire l'attention dans votre salon
- › Technologie de filament LED à économie d'énergie

## 110098 E27-LED-APPLE

<b>Dimensions</b> Abmessungen / Dimensions	L 220, Ø 220
<b>Socket</b> Sockel / Douille	E27
<b>Wattage</b> Wattage / Puissance	4 W
<b>Light Colour</b> Lichtfarbe / Couleur lumineuse	2200 K
<b>Operating voltage</b> Betriebsspannung / Tension de fonctionnement	220-240V, 50/60Hz
<b>Lifetime</b> Lebensdauer / Durée de vie	15000 h
<b>Colour rendering index</b> Farbwiedergabeindex / L'indice de restitution de couleurs	80



\*\*not suitable for general lighting / nicht für die Allgemeinbeleuchtung geeignet /  
n'est pas approprié pour l'éclairage général



## 110099 E27-LED-APPLE

<b>Dimensions</b> Abmessungen / Dimensions	L 220, Ø 220
<b>Socket</b> Sockel / Douille	E27
<b>Wattage</b> Wattage / Puissance	4 W
<b>Light Colour</b> Lichtfarbe / Couleur lumineuse	1900 K
<b>Operating voltage</b> Betriebsspannung / Tension de fonctionnement	220-240V, 50/60Hz
<b>Lifetime</b> Lebensdauer / Durée de vie	15000 h
<b>Colour rendering index</b> Farbwiedergabeindex / L'indice de restitution de couleurs	80



\*\*not suitable for general lighting / nicht für die Allgemeinbeleuchtung geeignet /  
n'est pas approprié pour l'éclairage général

## 110101 E27-LED-APPLE

<b>Dimensions</b> Abmessungen / Dimensions	L 220, Ø 220
<b>Socket</b> Sockel / Douille	E27
<b>Wattage</b> Wattage / Puissance	4 W
<b>Light Colour</b> Lichtfarbe / Couleur lumineuse	1600 K
<b>Operating voltage</b> Betriebsspannung / Tension de fonctionnement	220-240V, 50/60Hz
<b>Lifetime</b> Lebensdauer / Durée de vie	15000 h
<b>Colour rendering index</b> Farbwiedergabeindex / L'indice de restitution de couleurs	80



\*\*not suitable for general lighting / nicht für die Allgemeinbeleuchtung geeignet /  
n'est pas approprié pour l'éclairage général

## 110095 E27-LED-G200

<b>Dimensions</b> Abmessungen / Dimensions	L 255, Ø 200
<b>Socket</b> Sockel / Douille	E27
<b>Wattage</b> Wattage / Puissance	4 W
<b>Light Colour</b> Lichtfarbe / Couleur lumineuse	2200 K
<b>Operating voltage</b> Betriebsspannung / Tension de fonctionnement	220-240V, 50/60Hz
<b>Lifetime</b> Lebensdauer / Durée de vie	15000 h
<b>Colour rendering index</b> Farbwiedergabeindex / L'indice de restitution de couleurs	80



**BIG  
SIZE**  
L 255, Ø 200

4 W

**50 lm**  
LUMEN



\*\*not suitable for general lighting / nicht für die Allgemeinbeleuchtung geeignet /  
n'est pas approprié pour l'éclairage général



## 110096 E27-LED-G200

<b>Dimensions</b> Abmessungen / Dimensions	L 255, Ø 200
<b>Socket</b> Sockel / Douille	E27
<b>Wattage</b> Wattage / Puissance	4 W
<b>Light Colour</b> Lichtfarbe / Couleur lumineuse	1900 K
<b>Operating voltage</b> Betriebsspannung / Tension de fonctionnement	220-240V, 50/60Hz
<b>Lifetime</b> Lebensdauer / Durée de vie	15000 h
<b>Colour rendering index</b> Farbwiedergabeindex / L'indice de restitution de couleurs	80



**BIG  
SIZE**  
L 255, Ø 200

4 W

**40 lm**  
LUMEN



\*\*not suitable for general lighting / nicht für die Allgemeinbeleuchtung geeignet /  
n'est pas approprié pour l'éclairage général



## 110097 E27-LED-G200

<b>Dimensions</b> Abmessungen / Dimensions	L 255, Ø 200
<b>Socket</b> Sockel / Douille	E27
<b>Wattage</b> Wattage / Puissance	4 W
<b>Light Colour</b> Lichtfarbe / Couleur lumineuse	1600 K
<b>Operating voltage</b> Betriebsspannung / Tension de fonctionnement	220-240V, 50/60Hz
<b>Lifetime</b> Lebensdauer / Durée de vie	15000 h
<b>Colour rendering index</b> Farbwiedergabeindex / L'indice de restitution de couleurs	80



**BIG  
SIZE**  
L 255, Ø 200

4 W

**40 lm**  
LUMEN

warm  
WHITE

\*\*



\*\*not suitable for general lighting / nicht für die Allgemeinbeleuchtung geeignet /  
n'est pas approprié pour l'éclairage général



## 110109 E27-LED-E140

<b>Dimensions</b> Abmessungen / Dimensions	L 340, Ø 140
<b>Socket</b> Sockel / Douille	E27
<b>Wattage</b> Wattage / Puissance	8 W
<b>Light Colour</b> Lichtfarbe / Couleur lumineuse	2100 K
<b>Operating voltage</b> Betriebsspannung / Tension de fonctionnement	220-240V, 50/60Hz
<b>Lifetime</b> Lebensdauer / Durée de vie	15000 h
<b>Colour rendering index</b> Farbwiedergabeindex / L'indice de restitution de couleurs	80



8 W

**806 lm**  
LUMEN

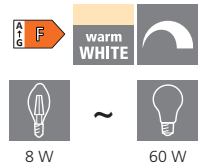

## 110111 E27-LED-PS160

<b>Dimensions</b> Abmessungen / Dimensions	L 320, Ø 160
<b>Socket</b> Sockel / Douille	E27
<b>Wattage</b> Wattage / Puissance	8 W
<b>Light Colour</b> Lichtfarbe / Couleur lumineuse	2100 K
<b>Operating voltage</b> Betriebsspannung / Tension de fonctionnement	220-240V, 50/60Hz
<b>Lifetime</b> Lebensdauer / Durée de vie	15000 h
<b>Colour rendering index</b> Farbwiedergabeindex / L'indice de restitution de couleurs	80



8 W

**806 lm**  
LUMEN

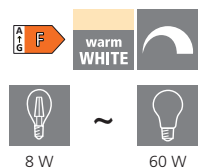



## 110112 E27-LED-G200

<b>Dimensions</b> Abmessungen / Dimensions	L 305, Ø 200
<b>Socket</b> Sockel / Douille	E27
<b>Wattage</b> Wattage / Puissance	8 W
<b>Light Colour</b> Lichtfarbe / Couleur lumineuse	2100 K
<b>Operating voltage</b> Betriebsspannung / Tension de fonctionnement	220-240V, 50/60Hz
<b>Lifetime</b> Lebensdauer / Durée de vie	15000 h
<b>Colour rendering index</b> Farbwiedergabeindex / L'indice de restitution de couleurs	80



**BIG  
SIZE**  
L 305, Ø 200

**8 W**

**806 lm**  
LUMEN

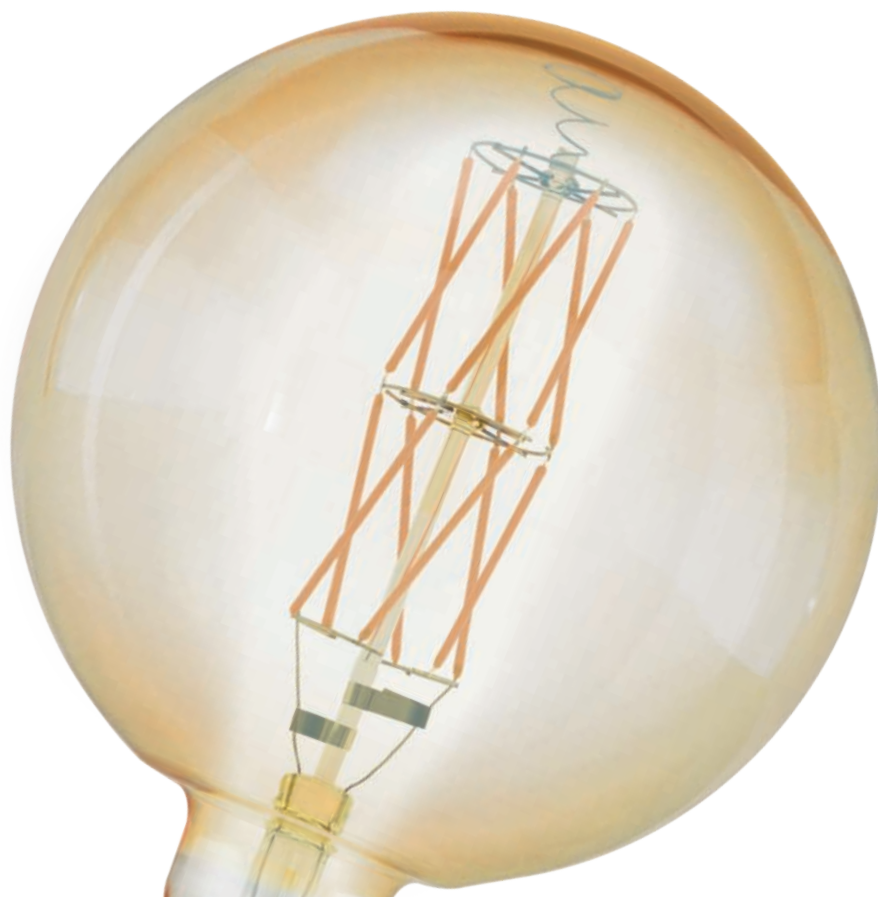

**11898 E27-LED-E170**

<b>Dimensions</b> Abmessungen / Dimensions	L 270, Ø 170
<b>Socket</b> Sockel / Douille	E27
<b>Wattage</b> Wattage / Puissance	4W
<b>Light Colour</b> Lichtfarbe / Couleur lumineuse	2700K
<b>Operating voltage</b> Betriebsspannung / Tension de fonctionnement	220-240V, 50/60Hz
<b>Lifetime</b> Lebensdauer / Durée de vie	25.000 h
<b>Colour rendering index</b> Farbwiedergabeindex / L'indice de restitution de couleurs	>80



**BIG  
SIZE**  
L 270, Ø 170

**4W**

**470 lm**  
LUMEN

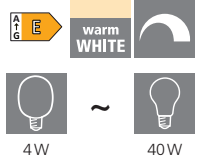

4W

40W



9 002759 118983

**11899 E27-LED-TS140**

<b>Dimensions</b> Abmessungen / Dimensions	L 200, Ø 140
<b>Socket</b> Sockel / Douille	E27
<b>Wattage</b> Wattage / Puissance	4W
<b>Light Colour</b> Lichtfarbe / Couleur lumineuse	2700K
<b>Operating voltage</b> Betriebsspannung / Tension de fonctionnement	220-240V, 50/60Hz
<b>Lifetime</b> Lebensdauer / Durée de vie	25.000 h
<b>Colour rendering index</b> Farbwiedergabeindex / L'indice de restitution de couleurs	>80



**BIG  
SIZE**  
L 200, Ø 140

**4W**

**470 lm**  
LUMEN



4W

40W



9 002759 118990

## 11901 E27-LED-G200

<b>Dimensions</b> Abmessungen / Dimensions	L 255, Ø 200
<b>Socket</b> Sockel / Douille	E27
<b>Wattage</b> Wattage / Puissance	4W
<b>Light Colour</b> Lichtfarbe / Couleur lumineuse	2700K
<b>Operating voltage</b> Betriebsspannung / Tension de fonctionnement	220-240V, 50/60Hz
<b>Lifetime</b> Lebensdauer / Durée de vie	25.000 h
<b>Colour rendering index</b> Farbwiedergabeindex / L'indice de restitution de couleurs	>80



4W

**470 lm**  
LUMEN

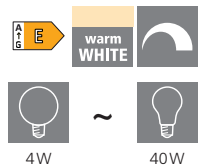

## 11902 E27-LED-R140

<b>Dimensions</b> Abmessungen / Dimensions	L 190, Ø 140
<b>Socket</b> Sockel / Douille	E27
<b>Wattage</b> Wattage / Puissance	4W
<b>Light Colour</b> Lichtfarbe / Couleur lumineuse	2700K
<b>Operating voltage</b> Betriebsspannung / Tension de fonctionnement	220-240V, 50/60Hz
<b>Lifetime</b> Lebensdauer / Durée de vie	25.000 h
<b>Colour rendering index</b> Farbwiedergabeindex / L'indice de restitution de couleurs	>80



4W

**470 lm**  
LUMEN

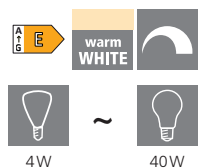

## 12591 E27-LED-E140

<b>Dimensions</b> Abmessungen / Dimensions	L 342, Ø 140
<b>Socket</b> Sockel / Douille	E27
<b>Wattage</b> Wattage / Puissance	4W
<b>Light Colour</b> Lichtfarbe / Couleur lumineuse	2200K
<b>Operating voltage</b> Betriebsspannung / Tension de fonctionnement	220-240V, 50/60Hz
<b>Lifetime</b> Lebensdauer / Durée de vie	15.000 h
<b>Colour rendering index</b> Farbwiedergabeindex / L'indice de restitution de couleurs	>80



**BIG  
SIZE**  
L 342, Ø 140

4W

**400 lm**  
LUMEN

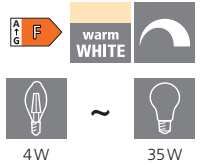

## 12592 E27-LED-PS160

<b>Dimensions</b> Abmessungen / Dimensions	L 318, Ø 160
<b>Socket</b> Sockel / Douille	E27
<b>Wattage</b> Wattage / Puissance	4W
<b>Light Colour</b> Lichtfarbe / Couleur lumineuse	2200K
<b>Operating voltage</b> Betriebsspannung / Tension de fonctionnement	220-240V, 50/60Hz
<b>Lifetime</b> Lebensdauer / Durée de vie	15.000 h
<b>Colour rendering index</b> Farbwiedergabeindex / L'indice de restitution de couleurs	>80



**BIG  
SIZE**  
L 318, Ø 160

4W

**400 lm**  
LUMEN

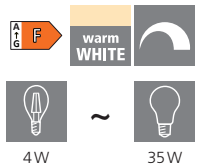

## 12593 E27-LED-G200

<b>Dimensions</b> Abmessungen / Dimensions	L 305, Ø 200
<b>Socket</b> Sockel / Douille	E27
<b>Wattage</b> Wattage / Puissance	4W
<b>Light Colour</b> Lichtfarbe / Couleur lumineuse	2200K
<b>Operating voltage</b> Betriebsspannung / Tension de fonctionnement	220-240V, 50/60Hz
<b>Lifetime</b> Lebensdauer / Durée de vie	15.000 h
<b>Colour rendering index</b> Farbwiedergabeindex / L'indice de restitution de couleurs	>80



**BIG  
SIZE**  
L 305, Ø 200

4W

**400 lm**  
LUMEN

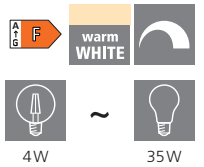

9 002759 125936



**11836 E27-LED-B80**

<b>Dimensions</b> Abmessungen / Dimensions	L 173, Ø 80
<b>Socket</b> Sockel / Douille	E27
<b>Wattage</b> Wattage / Puissance	4W
<b>Light Colour</b> Lichtfarbe / Couleur lumineuse	2200K
<b>Operating voltage</b> Betriebsspannung / Tension de fonctionnement	220-240V, 50/60Hz
<b>Lifetime</b> Lebensdauer / Durée de vie	25.000 h
<b>Colour rendering index</b> Farbwiedergabeindex / L'indice de restitution de couleurs	>80
<b>Selling Unit</b> Verpackungseinheit / Unité d'emballage	10

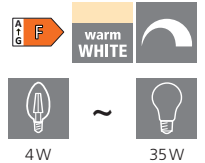
**4W****380 lm**  
LUMEN**11837 E27-LED-BR150**

<b>Dimensions</b> Abmessungen / Dimensions	L 160, Ø 150
<b>Socket</b> Sockel / Douille	E27
<b>Wattage</b> Wattage / Puissance	4W
<b>Light Colour</b> Lichtfarbe / Couleur lumineuse	2200K
<b>Operating voltage</b> Betriebsspannung / Tension de fonctionnement	220-240V, 50/60Hz
<b>Lifetime</b> Lebensdauer / Durée de vie	25.000 h
<b>Colour rendering index</b> Farbwiedergabeindex / L'indice de restitution de couleurs	>80

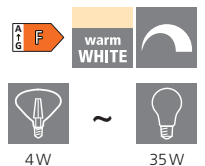
**4W****380 lm**  
LUMEN

## 12594 E27-LED-T125

<b>Dimensions</b> Abmessungen / Dimensions	L 180, Ø 125
<b>Socket</b> Sockel / Douille	E27
<b>Wattage</b> Wattage / Puissance	4W
<b>Light Colour</b> Lichtfarbe / Couleur lumineuse	2200K
<b>Operating voltage</b> Betriebsspannung / Tension de fonctionnement	220-240V, 50/60Hz
<b>Lifetime</b> Lebensdauer / Durée de vie	15.000 h
<b>Colour rendering index</b> Farbwiedergabeindex / L'indice de restitution de couleurs	>80



**4W**

**400 lm**  
LUMEN

**A++ F** warm WHITE

4W ~ 35W

9 002759 125943

## 12596 E27-LED-R140

<b>Dimensions</b> Abmessungen / Dimensions	L 152, Ø 140
<b>Socket</b> Sockel / Douille	E27
<b>Wattage</b> Wattage / Puissance	4W
<b>Light Colour</b> Lichtfarbe / Couleur lumineuse	2200K
<b>Operating voltage</b> Betriebsspannung / Tension de fonctionnement	220-240V, 50/60Hz
<b>Lifetime</b> Lebensdauer / Durée de vie	15.000 h
<b>Colour rendering index</b> Farbwiedergabeindex / L'indice de restitution de couleurs	>80



**4W**

**400 lm**  
LUMEN

**A++ F** warm WHITE

4W ~ 35W

9 002759 125967

**12586 E27-LED-G150**

<b>Dimensions</b> Abmessungen / Dimensions	L 200, Ø 150
<b>Socket</b> Sockel / Douille	E27
<b>Wattage</b> Wattage / Puissance	2W
<b>Light Colour</b> Lichtfarbe / Couleur lumineuse	2200K
<b>Operating voltage</b> Betriebsspannung / Tension de fonctionnement	220-240V, 50/60Hz
<b>Lifetime</b> Lebensdauer / Durée de vie	15.000 h
<b>Colour rendering index</b> Farbwiedergabeindex / L'indice de restitution de couleurs	>80
<b>Selling Unit</b> Verpackungseinheit / Unité d'emballage	10



**2W**

**200 lm**  
LUMEN

**A+** **F** warm **WHITE**

2W ~ 20W

9 002759 125868

**12584 E27-LED-G95**

<b>Dimensions</b> Abmessungen / Dimensions	L 139, Ø 93
<b>Socket</b> Sockel / Douille	E27
<b>Wattage</b> Wattage / Puissance	2W
<b>Light Colour</b> Lichtfarbe / Couleur lumineuse	2200K
<b>Operating voltage</b> Betriebsspannung / Tension de fonctionnement	220-240V, 50/60Hz
<b>Lifetime</b> Lebensdauer / Durée de vie	15.000 h
<b>Colour rendering index</b> Farbwiedergabeindex / L'indice de restitution de couleurs	>80
<b>Selling Unit</b> Verpackungseinheit / Unité d'emballage	10



**2W**

**200 lm**  
LUMEN

**A+** **F** warm **WHITE**

2W ~ 20W

9 002759 125844



## 12585 E27-LED

<b>Dimensions</b> Abmessungen / Dimensions	L 167, Ø 95
<b>Socket</b> Socket / Douille	E27
<b>Wattage</b> Wattage / Puissance	2W
<b>Light Colour</b> Lichtfarbe / Couleur lumineuse	2200K
<b>Operating voltage</b> Betriebsspannung / Tension de fonctionnement	220-240V, 50/60Hz
<b>Lifetime</b> Lebensdauer / Durée de vie	15.000 h
<b>Colour rendering index</b> Farbwiedergabeindex / L'indice de restitution de couleurs	>80
<b>Selling Unit</b> Verpackungseinheit / Unité d'emballage	10



**2W**

**200 lm**  
LUMEN

**A+** **F** **warm WHITE**

**2W** **20W**

9 002759 125851



# EGLO WORLDWIDE

EGLO WELTWEIT / EGLO DANS LE MONDE



 **AUSTRIA**  
EGLO LEUCHTEN GMBH

Heiligkreuz 22  
6136 Pill  
T: +43 5242 6996 0 | F: +43 5242 6996 972  
info-austria@eglo.com

 **CHILE**  
EGLO CHILE ILUMINACIÓN LTDA.

Av. Américo Vespucio Norte 1930  
Conchalí - Santiago de Chile  
T: +562 2 595 2222  
info-chile@eglo.com

 **DENMARK**  
EGLO DANMARK A/S

Agerbakken 20  
8362 Hørning  
T: +45 70 22 55 11 | F: +45 70 22 55 221  
info-denmark@eglo.com

 **AUSTRALIA**  
EGLO LIGHTING AUSTRALIA

5/339 Archerfield Road  
4077 Richlands | Queensland  
T: +61 7 3375 1413 | F: +61 7 3375 1412  
info@eglolighting.com.au

 **CHINA**  
DONGGUAN EGLO LIGHTING COMMERCIAL  
CO LTD

No.1 | Shangqiao Industrial Rd Shangqiao, Dongcheng  
Dongguancity, Guanzhouprovince  
T: +86 769 2203 3866 | F: +86 769 2203 6866  
info-china@eglo.com

 **ESTONIA**  
MOODNE VALGUSTUS AS

Rävalapst. 7  
10143 Tallinn  
T: +372 667 6670 | F: +372 631 3195  
info-global@eglo.com

 **BELGIUM**  
EGLO BELGIUM BV

Antwerpsesteenweg 247  
2950 Kapellen  
T: +32 3 250 60 80 | F: +32 3 219 80 67  
info-belgium@eglo.com

 **COLOMBIA**  
EGLO COLOMBIA ILUMINACIÓN SAS

Autopista Norte 800 Mts adelante del Peaje de los Andes  
Costado Oriental Km 19 Lote 30  
Bogotá - Chia  
T: +57 (1) 744 2339  
info-global@eglo.com

 **FINLAND**  
EGLO FINLAND OY

Malmiraitti 17A  
700 Helsinki  
T: +358 20 7649 820 | F: +358 20 7649 821  
info-finland@eglo.com

 **BOSNIA AND HERZEGOVINA**  
EGLO RASVJETA BH D.O.O.

Ormanica bb  
76250 Gradacac  
T: +387 35 86 85 00 | F: +387 35 82 44 41  
info-Bosnia-Herzegovina@eglo.com

 **COSTA RICA**  
EGLO COSTA RICA

Centro Comercial Calle Real local #8  
Guachipilín de Escazú de la sucursal del BAC  
San Jose 800 metros al norte | San Jose  
T: +506-2289-4690 | F: +506-2100-6384  
info-costarica@eglo.com

 **FRANCE**  
EGLO FRANCE LUMINAIRE SARL

Z.A. Jeune Bois | 2 Rue de la Martinique  
68274 Wittenheim  
T: +33 3 89 62 50 45 | F: +33 389 6250 49  
info-france@eglo.com

 **BULGARIA**  
EGLO BULGARIA EOOD

Main Road Burgas-Sofia | 5th kilometer | Building EGLO  
8000 Burgas  
T: +359 56 960 403 | F: +359 56 53 05 95  
info-bulgaria@eglo.com

 **CROATIA**  
EGLO RASVJETA D.O.O.

Jadranska avenija 9a  
10000 Zagreb  
T: +385 1 379 40 62 | F: +385 1 379 41 04  
info-croatia@eglo.com

 **GERMANY**  
EGLO LEUCHTEN HANDELS GMBH

Kleinbahnstr. 35  
59759 Arnsberg  
T: +49 2932 6269 0 | F: +49 2932 6269 39  
info-germany@eglo.com

 **CANADA**  
EGLO CANADA INC.

20700 Route Transcanadienne  
H9X 4B7 Baie D'Ufré, Quebec  
T: +1 514 457 5483 | F: +1 514 457 5487  
info-canada@eglo.com

 **CZECH REPUBLIC**  
EGLO CZ+SK s.r.o.

Náchodská 2479/63  
193 00 Praha 9 Horní Pocernice  
T: +420 281 924 163 | F: +420 281 925 205  
info-czechrepublic@eglo.com

 **GREAT BRITAIN AND IRELAND**  
EGLO UK LTD.

Unit 12 Cirrus Park, Lower Farm Road, Moulton Park  
Industrial Estate, Northampton NN3 6UR  
T: +44 1604 790 986 | F: +44 1604 670 282  
info-greatbritain@eglo.com

**GREECE**

EGLO HELLAS A.E.

Sykias 2 and parodos dekeleias  
13679 Acharnai  
T: +30 21 0800 2363 | F: +30 210 240 07 29  
info-greece@eglo.com

**HUNGARY - PRODUCTION AND LOGISTICS**

EGLO MAGYARORSZAG KFT.

Fő út. 155  
3060 Paszto  
T: + 36 32 560 050 | F: +36 32 560 040  
info-hungary@eglo.com

**INDIA**

EGLO INDIA PRIVATE LIMITED

A-307, Ansal Chambers - 1, 3, Bhikaji Cama Place,  
110066 Delhi  
T: +91 85279 44288  
info-india@eglo.com

**ITALY**

EGLO ITALIANA S.R.L.

Via Giotto, 4  
31021 Mogliano Veneto (TV)  
T: +39 041 45 66 232 / -245/ -251 |  
F: +39 041 45 74 066 / -071  
info-italy@eglo.com

**KAZAKHSTAN**

EGLO KAZAKHSTAN LLP

Al-Farabi Avenue 7, Office 72, 14rd floor, Block 4A,  
Nurly-Tau Business Center  
50059 Almaty  
T: +7 727 293 25 20 | M: +7 701 031 00 00  
info-kazakhstan@eglo.com

**KOSOVO**

EGLO KOSOVA LLC

Lugisht e qytetit pn  
20000 Prizren  
T: +377 44 2166 87 | SHOP: +381 29 2442 84  
info-kosovo@eglo.com

**LATVIA**

MOODNE VALGUSTUS AS

Rävalapst.7  
10143 Tallinn  
T: +370 652 49923 | T: +372 667 6670  
info-latvia@eglo.com

**LITHUANIA**

MOODNE VALGUSTUS AS

Rävalapst.7  
10143 Tallinn  
T: +370 652 49923 | T: +372 667 6671  
info-latvia@eglo.com

**MAGYARORSZÁG – ÉRTÉKESÍTÉS**

EGLO LUX KFT.

Fő út. 143/A  
2120 Dunakeszi  
T: +36 27 341 353 | F: +36 27 341 409  
info-hungary@eglo.com

**MALAYSIA**

EGLO ASIA SDN BHD

No. 13, Jalan Pelukis U1/46B, Temasya 18, Glenmarie,  
40150 Shah Alam, Selangor Darul Ehsan  
T: +6011 1050 2336 | F: +603 5567 9415  
info-malaysia@eglo.com

**MEXICO**

EGLO MÉXICO ILUMINACIÓN S DE RL DE CV

Prolongación Avenida López Mateos Sur N°3561,  
Fraccionamiento Los Gavilanes  
C.P. 45645 Tlajomulco de Zúñiga | Jalisco  
T: +52 33 3687 20 95  
info-mexico@eglo.com

**MIDDLE EAST**

EGLO LIGHTING MIDDLE EAST FZE

P.O. BOX 262073, LOB6, OFFICE G18  
Jebel Ali, Dubai, UAE  
T: +97 148810080 | F: +97 148810081  
gulf@eglo.com

**MOROCCO - EGLO AFRICA**

EGLO MAGHREB LUMINAIRES SARL

219 Bd Med Zerktoni. Suite: 67  
20330 Casablanca  
T: +212 522 98 80 25 / -05  
info-global@eglo.com | info.africa@eglo.com

**THE NETHERLANDS**

EGLO VERLICHTING NEDERLAND B.V.

Innovatiepark 20  
4906 AA Oosterhout (NBR)  
T: +31 162 48 28 30  
info.netherlands@eglo.com

**NORWAY**

MS Belysning AS

Heiaveien 4  
1900 Fetstund  
T: +47 63 888500 | F: +47 63 888501  
info-norway@eglo.com

**PERU**

EGLO PERU S.A.C

Av Primavera 1419  
Distrito de Santiago de Surco y Departamento de Lima  
T: +51 902 763 635  
info-peru@eglo.com

**POLAND**

EGLO POLSKA SP. Z O.O.

Ul. Dzwiekowa 2  
02-857 Warszawa  
T: +48 22 644 57 55 | F: +48 22 644 89 82  
info-poland@eglo.com

**PORTUGAL**

EGLO PORTUGAL ILUMINAÇÃO, LDA

Rua Fonte Parada, 125  
4595-434 Seroa-Paços de Ferreira  
T: +351 255 890 000 | F: +351 255 892 346  
info-portugal@eglo.com

**ROMANIA**

EGLO ROMANIA PRODEXIM SRL.

Str. Atomistilor nr. 1D  
77125 Magurele - Ilfov  
T: +40 314 250 902 | F: +40 314 250 899  
info-romania@eglo.com

**RUSSIA**

EGLO LIGHTING LLC

Varshavskoe shosse 3 | Office 23  
117105 Moscow  
T: +7495 789 4311 | F: +7495 789 4312  
info-russia@eglo.com

**SERBIA**

EGLO RASVETA DOO

Stefana Prvovenčanog 28  
11000 Beograd  
T: +381 11 3981 366 | F: +381 11 3981 389  
info-serbia@eglo.com

**SLOVAKIA**

EGLO CZ+SK s.r.o

Náchodská 2479/63  
193 00 Praha 9 Horní Počernice  
T: +421 313 211 551 | F: +421 313 211 556  
info-slovakia@eglo.com

**SLOVENIA**

EGLO RASVJETA D.O.O.

Jadranska avenija 9a  
10000 Zagreb  
T: +386 158 093 18  
info-slovenia@eglo.com

**SPAIN**

EGLO ESPAÑA ILUMINACION S.L.

Avda. de Castilla 1 (Edf. Best Point) 2º-16A  
28830 San Fernando de Henares, Madrid  
T: +34 91 677 9044 | F: +34 91 677 0304  
info-spain@eglo.com

**SWEDEN**

EGLO SVERIGE AB

Star Street 1  
512 50 Svenljunga  
T: +46 340 623 505 | F: +46 340 623 605  
info-sweden@eglo.com

**SWITZERLAND**

EGLO SCHWEIZ AG

Seetalstraße 142  
6032 Emmen  
T: +41 41 268 69 59 | F: +41 41 268 69 58  
info-switzerland@eglo.com

**TURKEY**

EGLO Aydınlatma ithalat ihracat Ltd. Şti.

Eyüp Sultan Mah. Sekmen Cad. No:18/2  
34855 Sancaktepe / Istanbul Samandira  
T: +90 216 311 09 -02 / -03 / -04 |  
F: +90 216 311 09 / -05  
info-turkey@eglo.com

**UKRAINE**

EGLO UKRAINE LTD

Vatslava Gavela boulevard, 6/7-A,  
03124 Kyiv  
T: +38 044 463 98 41 | F: +38 044 468 84 67  
info-ukraina@eglo.com

**USA**

EGLO USA, INC.

3640 Royal South Parkway  
30349 Atlanta, Georgia  
T: +1 404 477 5601 | F: +1 404 393 7053  
info-usa@eglo.com

# HOW TO READ

## ERKLÄRUNG / COMMENT LIRE

### DIMENSIONS DIMENSIONEN DIMENSIONS

all dimensions in mm | alle Größen in mm | toutes dimensions en mm

L = length | Länge | longueur

B = width | Breite | largeur

H = height | Höhe | hauteur

Ø = diameter | Durchmesser | diamètre

A = projection length | Ausladung | amplitude

ET = installation depth | Einbautiefe | profondeur utile

Base = base dimensions | Sockelmaße | dimensions de base

Attention! The dimensions relate solely to the sizes of the luminaire. Any air spaces that would be relevant for a safe operating of the lamp were not considered.

Achtung! Die Größen beziehen sich nur auf die Abmessungen der Leuchte. Etwaige Lufträume, die für einen sicheren Betrieb der Leuchte notwendig sind, werden nicht berücksichtigt.

Attention! Les dimensions se réfèrent à la taille de la lampe seulement. Espacements éventuels, que seraient importants pour une opération de la lampe sans danger, n'ont pas été considérés.

### PRODUCT / PRODUCT IN THE AMBIANCE PRODUKT / PRODUKTE IM AMBIENTE PRODUITS / PRODUITS DANS L'AMBIENCE

You can find the article number next to each product on the page and in the ambiance pictures.

Sie finden die Artikelnummer auf jeder Seite und neben jeder Abbildung des Produktes und auf unseren Ambientebildern.

Vous pouvez trouver le numéro d'article à la page et à côté de chaque produit dans les images de l'ambiance.

### BUTTONS BUTTONS BOUTONS

LED Lightcolour | LED Lichtfarbe | couleur de LED



Bulb included | Leuchtmittel inkludiert | ampoules inclus



### SKETCHES SKIZZEN CROQUIS

The sketches state the most meaningful dimensions. If a product is adjustable by will, a turquoise arrow marks this function and only the maximum dimensions are indicated.

Die Bemaßung der Skizzen umfasst jeweils die aussagekräftigsten Größen. Bei verstellbaren Produkten kennzeichnet ein türkiser Pfeil diese Funktion und nur die maximalen Größen werden angegeben.

Les dimensions des croquis comprennent les plus représentatives. Si un produit est réglable au choix, une flèche turquoise affiche cette fonction et rien que les dimensions maximales sont indiquées.



**43292 BRIDEKIRK**  
pendant light; steel, black / fabric, linen, natural  
Hängeleuchte; Stahl, schwarz / Textil, Leinen, natur  
luminaire en suspension; acier, noir / tissu, lin, nature

H 1100, Ø 400



9 002759 432928



**43314 COULSDON**  
pendant light; steel, black / film, black, white  
Hängeleuchte; Stahl, schwarz / Folie, schwarz, weiss  
luminaire en suspension; acier, noir / film, noir, blanc

H 1310, Ø 145



9 002759 433147



**DESCRIPTION  
BESCHREIBUNG  
DESCRIPTION**

The product description is composed as follows:  
luminaire type; enclosure material, enclosure colour / glass or shade material, glass or shade colour

Die Produktbeschreibung setzt sich wie folgt zusammen:  
Leuchtenart; Gehäusematerial, Gehäusefarbe / Schirm- bzw. Glasmaterial, Schirm- bzw. Glasfarbe

La description du produit est composée comme suit:  
type de luminaire; matériel de boîtier, couleur de boîtier / matériel de verre ou abat-jour, couleur de verre ou abat-jour



32469



43344



**DETAIL 43314**

The luminaire heads can be installed in 2 ways on the ceiling.  
Die Leuchtenköpfe können auf 2 Arten an die Decke montiert werden.  
Les têtes de luminaire peuvent être montées de 2 manières au plafond.

**SERIES NAME  
SERIENNAME  
NOM DE LA SÉRIE**

**32469 STAVERTON**

ceiling light; steel, black  
Deckenleuchte; Stahl, schwarz  
plafonnier; acier, noir

H 250, Ø 365



9 002759 324698

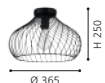

**43344 STAVERTON**

pendant light; steel, black  
Hängeleuchte; Stahl, schwarz  
luminaire en suspension; acier, noir

H 1100, Ø 365



9 002759 433444

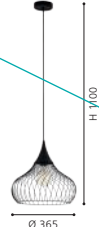

**ENERGY EFFICIENCY LABELS  
ENERGIEEFFIZIENZ-LABEL  
LABEL DE L'EFFICACITÉ ÉNERGÉTIQUE**



The new energy label must be indicated on all light sources with a luminous flux between 60 and 82,000 lumens and OLED. This applies to lamps, LED modules and luminaires where the light source cannot be removed without destroying it.

Das neue Energielabel muss auf allen Lichtquellen mit einem Lichtstrom zwischen 60 und 82.000 Lumen und OLED angegeben werden. Dies gilt für Lampen, LED-Module und Leuchten, bei denen die Lichtquelle nicht zerstörungsfrei entnommen werden kann.

Le nouveau label énergétique doit être indiqué sur toutes les sources lumineuses dont le flux lumineux est compris entre 60 et 82 000 lumens et sur les OLED. Cela s'applique aux lampes, aux modules LED et aux luminaires dont la source lumineuse ne peut être retirée sans être détruite.

**The information on the label includes: / Die Angaben auf dem Etikett beinhalten: / Les informations figurant sur l'étiquette sont les suivantes :**

- › Name/Trademark  
Name/Warenzeichen  
Nom/marque de commerce
- › Model / Modell / Modèle
- › Energy label scale A-G / Energielabel-Skala A-G / Échelle d'étiquetage énergétique A-G
- › Energy consumption for 1,000 hours of use/  
Energieverbrauch bei 1.000 Stunden Nutzung/  
Consommation d'énergie pour 1 000 heures d'utilisation
- › Energy efficiency class of the product/  
Energieeffizienzklasse des Produkts/  
Classe d'efficacité énergétique du produit
- › QR Code to EPREL (Product Database of the European Product Registry for Energylabelling)/  
QR Code zur EPREL (Produktdatenbank der European Product Registry for Energylabelling)/  
Code QR pour EPREL (base de données des produits du registre européen des produits pour l'étiquetage énergétique)
- › The energy spectrum ranges from G to A.  
Das Energiespektrum reicht von G bis A.  
Le spectre énergétique va de G à A.

**PICTOGRAMMES  
PIKTOGRAMME  
PICTOGRAMMES**

Technical details are represented as pictograms. An overview over all pictograms can be found on the next pages.

Technische Details werden als Piktogramme dargestellt. Eine Übersicht über alle Piktogramme finden Sie auf den nächsten Seiten.

Les détails techniques sont représentés sous forme de pictogrammes. Vous trouverez un aperçu de tous les pictogrammes dans les pages suivantes.

# Look out for this Logo!

## Achten Sie auf das Logo!

## Soyez attentif au logo !

### What is a forest?

A peaceful oasis, the green lungs of the world, and an adventure playground for children of all ages!

The Forest Stewardship Council® (FSC®) is a global, not-for-profit organisation dedicated to the promotion of responsible forest management worldwide. The FSC® defines standards for responsible forest management in accordance with established principles that are developed and supported by stakeholders from the environmental, social and economic spheres. For more information, please see [www.fsc.org](http://www.fsc.org).

### Was ist Wald für uns?

Eine Oase der Ruhe, die Lunge der Welt oder ein Abenteuerspielplatz für große und kleine Kinder!

Das Forest Stewardship Council® (FSC®) ist eine globale, gemeinnützige Organisation, mit dem Zweck verantwortungsvolle Waldbewirtschaftung weltweit zu fördern. FSC® definiert Standards für eine verantwortungsvolle Waldbewirtschaftung nach festgelegten Prinzipien, die von Interessenvertretern aus den Bereichen Umwelt, Soziales und Wirtschaft entwickelt und getragen werden. Für weitere Informationen besuchen Sie [www.fsc.org](http://www.fsc.org).

### Que représente la forêt pour nous ?

Une oasis de calme, les poumons du monde ou un terrain de jeu d'aventure pour les enfants de tous âges !

Le Forest Stewardship Council® (FSC®) est une organisation internationale à but non lucratif dont le but est de promouvoir une gestion forestière responsable dans le monde entier. Le FSC® définit des normes de gestion forestière responsable selon des principes établis qui sont développés et soutenus par les parties prenantes des secteurs environnemental, social et économique. Pour plus d'informations, veuillez consulter [www.fsc.org](http://www.fsc.org).

Look out for FSC® -certified products!  
Achten Sie auf FSC® -zertifizierte Produkte!  
Soyez attentif aux produits certifiés FSC® !



The mark of  
responsible forestry

# DIGITAL CATALOGUE

This year, we are also making the Trend & Style catalogue in front of you available online, including lots of extra information and additional features. In addition to search and filter functions, the online catalogue includes extensive product photos, videos and additional information, complementing the paper edition wonderfully. Take a look at

<https://catalogue.eglo.com>

In diesem Jahr präsentieren wir den vor Ihnen liegenden Trend & Style Katalog wieder als Online-Katalog mit vielen Zusatzinformationen und zusätzlichen Features. Neben Such- und Filterfunktionen bietet der Online-Katalog mit reichhaltigen Produktabbildungen, Videos und zusätzlichen Informationen einen erheblichen Mehrwert zur gebundenen Ausgabe. Klicken Sie sich rein unter <https://catalogue.eglo.com>

Cette année, nous présentons le catalogue Trend & Style devant vous pour la première fois en tant que catalogue en ligne avec de nombreuses informations complémentaires et des informations complémentaires Caractéristiques. Cette version contient de nombreuses informations et fonctionnalités complémentaires. Outre les fonctionnalités de recherche et de filtrage, le catalogue en ligne propose de nombreuses illustrations de produits, des vidéos et des informations complémentaires : une valeur ajoutée considérable par rapport à la version papier. Cliquez ici pour le découvrir : <https://catalogue.eglo.com>

NEW/ NEU/ NOUVEAU





















43413















































# LEGEND

## PICTOGRAM PIKTOGRAMME PICTOGRAMME

### SOCKETS FASSUNGEN DOUILLES

 LED	 G4	 G53
 2G7	 G5	 GU5,3 / MR16
 2G11	 G9	 GU10
 2GX13	 G10Q	 GX53
 E14	 G13	 GY6,35
 E27	 G23	 R7s

### BULBS LEUCHTMITTEL AMPOULES

 E14 / C35	 E27 / A60 Halogen	 E27 / E140 Filament
 E14 / C35f	 E27 / R63 Halogen	 E27 / PS160 Filament
 E14 / D45	 E27 / A60 LED	 E27 / T30 Filament
 E14 / C35f LED	 E27 / A60 Filament	 E27 / T32 Filament
 E14 / D45 Halogen	 E27 / A65 LED	 G4 / T9
 E14 / C35 Halogen	 E27 / A75 Filament	 G4 / LT9
 E14 / T22	 E27 / G45 LED	 G4 / LT14
 E14 / C35 Filament	 E27 / G45 Filament	 G9
 E14 / C37 Filament	 E27 / G80 Filament	 G9 LED
 E14 / C35f Filament	 E27 / G95	 GU10
 E14 / C37f Filament	 E27 / G95 Filament	 GU10 LED
 E14 / P45 LED	 E27 / G125	 GU10 SMD LED
 E14 / P45 Filament	 E27 / G95 LED	 GX53 / LF75
 E14 / P50	 E27 / G200 Filament	<b>LED</b> LED board / LED Platine / LED bord
 E14 / ST48 Filament	 E27 / R63 LED	 MR16
 E14 / ST64 Filament	 E27 / ST48 Filament	 MR16 LED
 E14 / T20 LED	 E27 / ST64 Filament	 R7s / 78mm
 E27 / A60	 E27 / B80 Filament	 R7s / 118mm
 E27 / G90	 E27 / BR150 Filament	 R7s / 78mm LED
 E27 / QR63	 E27 / DP165 Filament	 R7s / 118mm LED













**LIGHT COLOUR & LUMEN**  
**LICHTFARBE & LUMEN**  
**COULEUR LUMINEUX & LUMEN**

















The colours of the LED are represented as pictogrammes (see below), their luminous flux directly beneath. The luminous flux is quoted in lumen and describes the amount of light generated by the LED. The higher the value, the brighter is the lamp. Lumens are LED boards and are the light measurement value in bulbs.

Die Farben der LED werden als Piktogramm (siehe unten) dargestellt, deren Lichtstrom direkt darunter. Der Lichtstrom wird in Lumen gemessen und gibt die erzeugte Lichtmenge der LED an. Je höher der Wert, desto heller das Produkt. Lichtstromangaben (Lumen) sind Platinen- bzw. Leuchtmittelwerte.

Les couleurs de LED ont représentés sous forme de pictogrammes, leur flux lumineux directement en dessous. L'unité de flux lumineux est le lumen et il mesure la quantité de lumière générée par les LED. Plus la valeur est élevée, plus la lampe est lumineuse. Les lumens sont l'unité de mesure de l'intensité lumineuse des ampoules et des panneaux led intégrés.

 RGB RGB RGB	 RGB + tunabel white RGB + tunabel white RGB + tunabel white
 RGB + white RGB + weiß RGB + blanc	 tunable white tunable white tunable white
 RGB + warmwhite RGB + warmweiß RGB + blanc chaud	 warm white warmweiß blanc chaud
 RGB + coldwhite RGB + kaltweiß RGB + blanc froid	 cold white kaltweiß blanc froid
 RGB + neutralwhite RGB + neutralweiß RGB + blanc neutral	 neutral white neutralweiß blanc neutre

**SWITCHES & SENSORES**  
**SCHALTER & SENSOREN**  
**INTERRUPTEUR & CAPTEURS**

 incl. cable & plug inkl. Kabel & Stecker câble & connecteur inclus	 pedal switch Trittschalter interrupteur à pied	 swedish plug Stecker Schweden connecteur swede
 internal dimmer eingebauter Dimmer variateur intégré	 cable switch Kabelschalter interrupteur à câble	 "Touch me" ON/OFF "Touch me" EIN/AUS "Touch me" ON/OFF
 button switch Druckknopf interrupteur de pression	 incl. cable & plug transformer inkl. Kabel & Stecktransformator câble & transformateur à prise	 "Touch me" ON/OFF & dimm "Touch me" EIN/AUS & Dimmen "Touch me" ON/OFF & graduable
 function switch Funktionsschalter interrupteur fonction	 remote control Fernbedienung télécommande	 pull switch Zugschalter interrupteur à bascule
 rocker switch Wippschalter interrupteur à bascule	 Day & Night Sensor Tag & Nacht Sensor sensor jour & nuit	 Timer - automatic on/off Zeitschaltuhr - automatisches Ein- & Ausschalten minuterie - peut être éteint et allumé automatiquement
 pedal dimmer Trittdimmer variateur à pied	 sensor Sensor sensor	

**FUNKTIONS & COMFORT**  
**FUNKTIONEN & KOMFORT**  
**FONCTIONS & CONFORT**



 incl. battery inkl. Akku incl. pile	 cutout (in mm) Ausschnitt (in mm) perçage du panneau (en mm)	 shortable kürzbar réductible
 incl. battery inkl. Batterie incl. pile	 dimmable dimmbar graduable	 Voltage Volt Voltage
 battery specifications Batteriespezifikationen spécifications des piles	 not dimmable nicht dimmbar ne pas graduable	 WATT Watt
 beam angle Ausstrahlwinkel angle de rayonnement	 replaceable LED austauschbare LED LED remplaçables	 Flicker-Free Flacker-Frei Sans Vacillements
 corner mount possible Eckmontage möglich montage en coin possible	 loadable in kg belastbar in kg chargeable en kg	 not suitable for general lighting nicht für die Allgemeinbeleuchtung geeignet n'est pas approprié pour l'éclairage général
 CRI Colour Rendering Index	 packaging / delivery unit Verpackungs- / Liefereinheit unité d'emballage / de livraison	

**PROTECTION CLASS**  
**SCHUTZKLASSE**  
**CLASSE DE PROTECTION**

The protection class indicates to what extent the lamp is protected against electric shock. All lamps in this catalogue are at least protected with the protection class 1 - a higher class is specified in the information box of the respective lamp.

Die Schutzklasse gibt an, inwiefern ein Produkt gegen einen elektrischen Schlag gesichert ist. Alle Leuchten in diesem Katalog sind mit mindestens Schutzklasse 1 gesichert, bei höheren Klassen wird das Symbol im Infokasten der Leuchte angegeben.

La classe de protection indique, dans quelle mesure la lampe est protégé contre les chocs électriques. Tous les lampes dans ce catalogue sont protégées au moins avec la classe 1 - une classe plus élevée est indiquée dans l'information de la lampe.

 protection class 1: protective earthing Schutzklasse 1: Schutzerdung classe de protection 1: prise de terre	 protection class 2: protective insulation Schutzklasse 2: Schutzisolation classe de protection 2: double isolation ou renforcée	 protection class 3: protective low voltage Schutzklasse 3: Schutzkleinspannung classe de protection 3: très basse tension de sécurité
---	---	---

**PROTECTION RATING**  
**SCHUTZGRAD**  
**INDICE DE PROTECTION**

The protection rating ensures the operational safety of luminaires. The first number specifies the extent of the protection against the ingress of foreign bodies, the second number identifies the humidity protection grade. All luminaires in this catalogue are at least protected with the rating IP20 - a higher rating is specified in the information box of the luminaire.

Der Schutzgrad gewährleistet die Betriebssicherheit von Leuchten. Die erste Ziffer des IP Grades beschreibt den Schutzzumfang gegen das Eindringen von Fremdkörpern, die zweite Ziffer informiert über den Grad des Feuchtigkeitsschutzes. Alle Leuchten in diesem Katalog sind mit mindestens Schutzgrad IP20 gesichert, bei höheren Graden wird das Symbol im Infokasten der Leuchte angegeben.

L'indice de protection assure la sécurité opérationnelle des luminaires. Le premier chiffre indique à quel point la protection est efficace contre l'insertion de corps étrangers, le second chiffre indique quant à lui le degré de protection par rapport à l'humidité. Tous les luminaires dans ce catalogue sont protégés au moins avec l'indice IP20 - un indice plus élevé est indiqué dans l'information d'article.

 IP33	 IP44	 IP54	 IP65	 IP67
--	--	--	---	--

# REGISTER

SERIES NAMES

SERIENNAMEN

NOME DE PRODUITS

NAME NAME NOM	PAGE SEITE PAGE	NAME NAME NOM	PAGE SEITE PAGE	NAME NAME NOM	PAGE SEITE PAGE	NAME NAME NOM	PAGE SEITE PAGE
ADWICKLE	219	CARLTON 6	118	FINDLAY	205	LM_LED_E27	274-287
ALDERNEY	218	CARLTON 7	116-17	FORESTBURG	25	LONCINO	58
AMSFIELD	237	CARLTON-P	122-123	FRIJOLAS	192	LUBENHAM	38-39
ANWICK	220-221	CASTANUELO	142-143	GATEBECK	68-69	LUBENHAM 1	38
ANWICK 1	222	CATTERICK	18-19	GIACONECCHIA	188-189	LYNTON	192
ARNHEM	244, 246	CHARTERHOUSE	59	GILTSPUR	198	MADRESELVA	80
AUCKLAND	44	CHASELY	78	GLASTONBURY	164	MANBY	14-15
AUSNBY	229	CHERTSEY	212	GLYNEATH	228	MARDYKE	56-57
AUSTELL	158-59	CHESTER	167	GRANTHAM 1	43	MATLOCK	184-185, 186-187
AYCLIFFE	238	CHESTER 1	167	HALKIN	90	MEDIOUNA	246
AYESGARTH	236	CHESTER-P	168	HAMBLETON	252	MELILLA	260
AYLES	34-37	CHIEVELEY	88-89	HAPTON	173	MEOPHAM	212
BARNSTAPLE 1	32	CHISLE	199	HARBOROUGH	72	MILLIGAN	6-7,8-9
BARNSTAPLE 1	33-32	CLAVERDON	234-235	HAXEY	239	MONMOUNT	92
BASILDON	100	CLEVEDON	154	HETTONLE	238	MUMBLES	139
BASILDON	100 -101	CONSETT	90-91	HILCOTT	26-27	NAFFERTON	94-95
BASILDON 1	98	COPLEY	170-171	HODSOLL	211	NEWTOWN	156-157
BAZELY	181	CORETTO 2	172	HOGSMILL	214	NIMLET	251
BIDFORD	164-165	COTTINGHAM	208	HORNINGTOPS	209	OLDBURY	62
BORDESLEY	226-227	COULSDON	256	HORNWOOD	82-83	PADSTOW	208-209
BOYLE	80-31	COVALEDA	53	HORNWOOD 1	162-163	PALMORLA	112
BRADFORD	248-249	COVALEDA 1	50	HORNWOOD 2	79	PLIMSOLL	161
BRADFORD 1	249	CRANLEY	268	HYKEHAM	224-225	POMPEYA	178-179
BRAMERTON	86-87	DELLOW	12-13	IKESTON	20-21	PORT SETON	63
BRICKFIELD	24	DEMBLEBY	232-233	IPSDEN	98	PRESTWICK	192
BRIDEKIRK	256	DEMBLEBY 1	230	JADIDA	263	PRESTWICK 1	67
BRIDPORT	215	DISTAFF	113	JUBILY	10-11	PRESTWICK 2	66-67
CALARI	270	DUNDEE	168	KENSAL	250	PRESTWICK 3	190-191
CALLOW	102	EBURY	41	KILNSDALE	74	PRIDDY	45-46,48
CAPOSILE	252	EDALE	242	KINROSS	252	RAMPSTEAD	205-206,207
CARDIGAN	264	ELSWICK	60	KIRKCOLM	238	RAMPSTEAD 1	204
CARLTON	125-127	EMBLETON	54	LACEY	84-85	REDCLIFFE	16-17
CARLTON 1	114-115, 120-121,122	EVESHAM	72-73	LANTADA	165	ROCCAMENA	152-153
CARLTON 2	134-135	EXMOOR	61	LATCHELY	215	ROCKINGHAM	42
CARLTON 4	118	FAMBOROUGH	92-93	LAYHAM	70-71	RODING	210
CARLTON 5	119-120	FEMBARD	60	LITTLETON	96-97	RUSCOMB	200

NAME NAME NOM	PAGE SEITE PAGE	NAME NAME NOM	PAGE SEITE PAGE
SAFI	258	WILMCOTE	61
SALLICANO	181	WINKWORTH 1	40
SEDBERGH	23	WOOTTON	202-203
SHERBURN	103	WRINGTON	174-175
SHIREBROOK	33	WRINGTON 1	176-177
SOUTHERY	140-141	YORTH	269, 271
SPEKE	22	YOUNGSTOWN	204
STAVERTON	257		
STEELEVILLE	263		
STILLINGTON	136-137		
STOCKBURY	213		
STRAITON	130- 131,172-173		
STYPE	128-129		
SUDBURY	265		
SURFLEET	239		
TAKELEY	30		
TALBOT	265		
TALBOT 2	260		
TAMALLAT	261		
TARBES	134,144,145, 147-150,151		
TARBES 2	146		
TARLE	208		
TOWNSHEND	104-109		
TOWNSHEND 2	253		
TOWNSHEND 4	63-64,65		
TOWNSHEND 5	109-110,111		
TREBURLEY	50		
TRURO	44		
TRURO 1	42		
TRURO 2	42, 44		
TURROCK	28,29		
TWICKEN	182-183		
VERNHAM	133		
VINOZA	196		



# REGISTER

ARTICLE NUMBER  
ARTIKELNUMMER  
NUMÉROS D'ARTICLE

NUMBER NUMMER NUMÉRO	PAGE SEITE PAGE	NUMBER NUMMER NUMÉRO	PAGE SEITE PAGE	NUMBER NUMMER NUMÉRO	PAGE SEITE PAGE	NUMBER NUMMER NUMÉRO	PAGE SEITE PAGE	NUMBER NUMMER NUMÉRO	PAGE SEITE PAGE	NUMBER NUMMER NUMÉRO	PAGE SEITE PAGE
11836	284	39835	189	43168	38	43318	204	43402	244	43483	133
11837	284	39854	26	43184	50	43319	204	43403	244	43493	200
11898	280	39855	26	43192	207	43322	214	43404	212	43494	200
11899	280	39856	27	43194	205	43324	222	43405	212	43495	200
11901	281	39857	27	43195	206	43325	222	43413	92	43499	199
11902	281	39868	27	43197	206	43326	222	43414	93	43522	63
12584	286	43001	121	43199	207	43328	208	43415	93	43523	64
12585	287	43002	120	43216	226	43331	174	43416	93	43524	64
12586	286	43004	134	43217	227	43333	174	43424	82	43525	65
12591	282	43045	82	43218	226	43334	175	43425	162	43526	65
12592	282	43046	82	43219	227	43344	257	43426	162	43527	199
12593	283	43047	83	43231	226	43351	204	43427	163	43528	199
12594	285	43048	83	43251	235	43352	209	43428	163	43531	13
12596	285	43057	118	43252	234	43353	50	43429	163	43532	13
31073	270	43058	118	43253	234	43358	131	43431	32	43533	13
31075	270	43077	119	43254	234	43359	130	43432	32	43534	16
32468	175	43078	120	43256	206	43361	130	43433	32	43535	16
32469	257	43096	175	43261	233	43363	209	43434	33	43536	17
32522	269	43113	238	43262	232	43364	208	43435	40	43537	17
32531	269	43126	61	43263	232	43365	60	43436	40	43538	17
32539	269	43129	78	43264	233	43366	130	43443	142	43541	88
32915	106	43131	110	43265	230	43374	176	43444	28	43542	88
32916	106	43132	110	43266	230	43375	177	43445	28	43543	89
32917	107	43133	111	43285	229	43376	176	43446	28	43544	89
32918	107	43134	109	43292	256	43377	176	43447	29	43545	80
32919	107	43135	110	43299	42	43378	112	43459	78	43546	80
33162	105	43136	111	43303	178	43379	112	43461	100	43548	67
33163	105	43137	111	43304	179	43389	215	43462	100	43549	67
33164	104	43141	164	43305	179	43393	246	43463	101	43551	98
33165	104	43152	63	43307	179	43394	24	43464	101	43552	98
33166	104	43159	72	43308	25	43395	24	43466	70	43553	198
33167	105	43162	38	43309	25	43396	211	43468	70	43554	198
39831	188	43163	39	43311	220	43397	211	43469	70	43555	246
39832	188	43164	38	43312	221	43398	221	43471	71	43556	246
39833	189	43165	39	43313	220	43399	118	43481	133	43558	83
39834	189	43166	39	43314	256	43401	244	43482	133	43559	181

NUMBER NUMMER NUMÉRO	PAGE SEITE PAGE	NUMBER NUMMER NUMÉRO	PAGE SEITE PAGE	NUMBER NUMMER NUMÉRO	PAGE SEITE PAGE	NUMBER NUMMER NUMÉRO	PAGE SEITE PAGE	NUMBER NUMMER NUMÉRO	PAGE SEITE PAGE	NUMBER NUMMER NUMÉRO	PAGE SEITE PAGE
43561	30	43628	6	43684	147	43755	102	43812	139	43852	225
43562	30	43629	108	43685	147	43756	102	43813	139	43853	224
43569	98	43631	170	43692	128	43758	268	43814	125	43854	224
43576	261	43632	171	43693	129	43766	136	43815	125	43855	225
43577	261	43633	170	43695	128	43767	136	43816	140	43866	236
43581	113	43634	170	43696	129	43768	137	43817	140	43867	236
43582	113	43635	80	43715	117	43769	136	43818	140	43868	238
43587	263	43636	81	43716	116	43771	18	43819	141	43869	239
43591	202	43641	92	43717	117	43772	18	43821	23	43871	238
43592	202	43642	250	43718	117	43773	18	43822	23	43872	228
43593	202	43643	56	43721	22	43774	19	43823	196	43873	228
43594	203	43644	57	43722	22	43775	219	43824	196	43874	239
43595	190	43645	56	43723	237	43776	219	43825	184	49024	123
43596	191	43646	56	43724	90	43777	219	43826	185	49026	122
43597	191	43647	8	43725	91	43781	242	43827	186	49037	61
43598	190	43648	8	43726	33	43782	242	43828	186	49039	168
43599	143	43649	9	43728	20	43783	242	43829	186	49076	68
43603	12	43651	9	43729	21	43784	218	43831	229	49077	68
43604	12	43652	251	43731	20	43785	218	43832	74	49078	68
43605	12	43653	251	43732	21	43786	218	43833	74	49079	69
43606	79	43654	146	43733	66	43794	15	43834	74	49081	134
43611	84	43655	146	43734	67	43795	14	43835	183	49111	192
43612	84	43661	11	43735	85	43796	14	43836	183	49141	154
43613	85	43662	10	43736	101	43797	15	43837	183	49142	154
43614	85	43663	10	43738	103	43798	90	43838	182	49143	154
43615	192	43664	10	43739	103	43799	90	43839	182	49148	165
43617	210	43665	11	43743	95	43801	269	43841	182	49156	164
43618	210	43666	11	43744	94	43802	269	43842	185	49201	264
43619	210	43668	181	43745	95	43803	269	43843	187	49202	264
43621	41	43669	181	43746	95	43804	73	43844	185	49213	248
43622	41	43671	79	43748	87	43805	72	43845	208	49214	248
43623	249	43678	147	43749	87	43806	73	43846	116	49221	265
43624	249	43679	144	43751	86	43807	73	43847	161	49235	44
43625	6	43681	144	43752	86	43808	143	43848	161	49238	42
43626	6	43682	145	43753	86	43809	143	43849	161	49243	44
43627	7	43683	145	43754	87	43811	139	43851	224	49247	42

NUMBER NUMMER NUMÉRO	PAGE SEITE PAGE	NUMBER NUMMER NUMÉRO	PAGE SEITE PAGE	NUMBER NUMMER NUMÉRO	PAGE SEITE PAGE	NUMBER NUMMER NUMÉRO	PAGE SEITE PAGE
49248	44	49488	134	49772	237	110109	278
49254	114	49489	252	49809	63	110111	278
49255	122	49492	45	49812	192	110112	279
49257	126	49495	58	49814	258		
49258	126	49496	58	49815	258		
49259	126	49509	159	49819	43		
49274	264	49519	167	49851	252		
49276	265	49549	97	49859	65		
49283	249	49564	60	49871	258		
49284	248	49617	53	49877	53		
49337	168	49618	53	49878	114		
49342	168	49619	36	49927	253		
49385	167	49643	152	49931	122		
49386	167	49644	152	49932	120		
49392	59	49645	153	49933	127		
49393	59	49646	153	49935	127		
49394	59	49647	36	49991	115		
49446	159	49648	35	49992	115		
49447	158	49649	34	49994	115		
49448	158	49652	34	49997	114		
49449	173	49653	34	94187	148		
49452	215	49684	62	94188	148		
49456	213	49685	62	94189	149		
49457	213	49694	205	94191	148		
49458	213	49698	97	94192	149		
49464	46	49714	260	94193	151		
49465	46	49717	260	94194	150		
49466	46	49718	37	94195	150		
49468	48	49722	36	94196	151		
49469	48	49724	252	94197	151		
49471	48	49736	173	94324	165		
49472	156	49738	172	94326	165		
49473	96	49744	109	94742	172		
49474	157	49755	108	95499	106		
49475	96	49761	54	110095	276		
49477	156	49762	54	110096	276		
49478	156	49764	263	110097	277		
49479	157	49765	263	110098	274		
49481	157	49768	260	110099	275		
49487	135	49771	237	110101	275		



# NOTES

NOTIZEN

NOTES

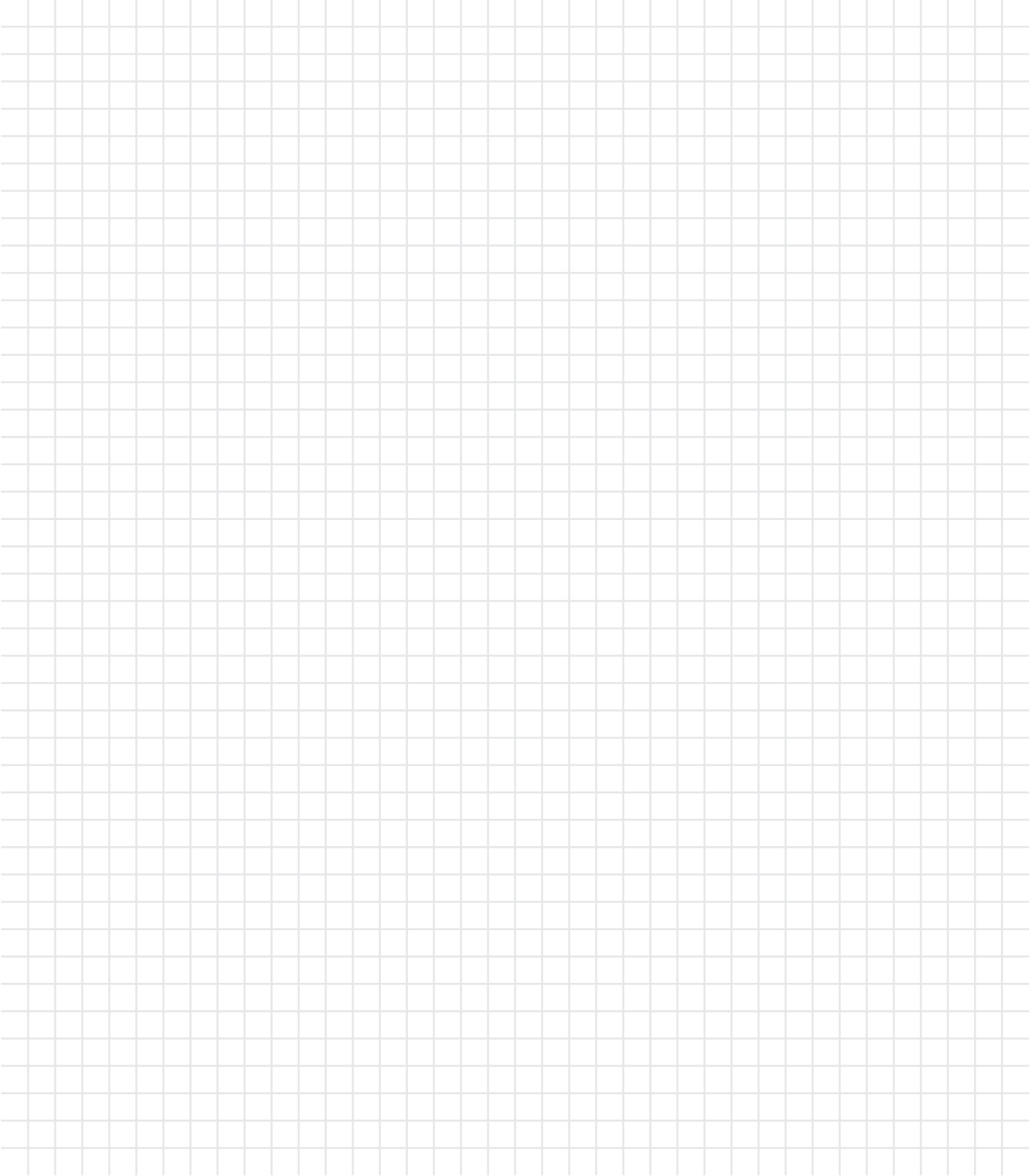



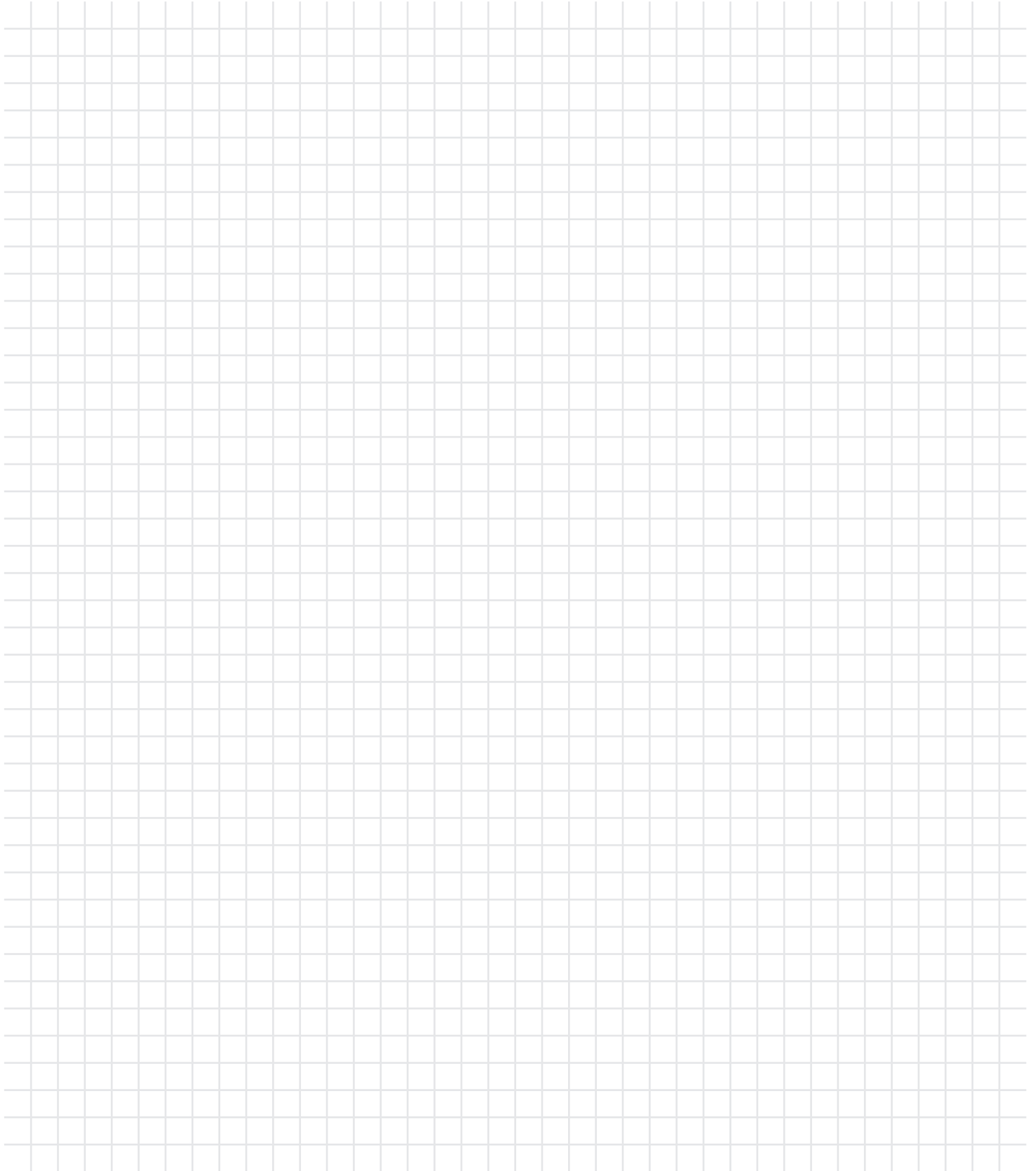



All previous catalogues and price lists are no longer valid with the issue of this catalogue. Errors, misprints, model and price changes and technical modifications are reserved. We deliver based on our terms of delivery and payment. Our products comply with the European light norm EN60598. Products with the ENEC test mark are conforming to the guide line 2006/95/EG. Products with additional safety remarks (e.g protection class, IP) are identified within the product family with the relevant symbol and number. The content of this catalogue is protected under copyright law for EGLO Leuchten GmbH. All rights reserved. Our specific written consent must be obtained before using any illustrations and texts. The pictures are 4C prints and may differ from the original. The product pictures and ambiances in this catalogue can deviate from reality, and they do not necessarily concur with the usual application of the product. EGLO does not assume liability for the correctness, completeness or the application depiction of the products and/or the product information.

Design, layout and composition:

EGLO GmbH, 6136 Pill - AUSTRIA

Print: Samson Druck GmbH, 5581 St. Margarethen - AUSTRIA

Pictures: EGLO, Adobe Stock, istockphoto.com, shutterstock.com

Mit diesem Katalog verlieren alle vorhergehenden Kataloge und Preislisten ihre Gültigkeit. Irrtümer, Druckfehler, Modell- und Preisänderungen sowie technische Änderungen vorbehalten. Wir liefern zu unseren Liefer- und Zahlungsbedingungen. Unsere Produkte entsprechen der europäischen Leuchtnorm EN 60598. Produkte mit dem ENEC Prüfzeichen sind konform mit der Richtlinie 2006/95/EG. Produkte mit weiteren Sicherheitshinweisen (zB. Schutzklasse, IP) sind mit Symbol und Zahl bei der Produktfamilie ausgezeichnet. Der Inhalt dieses Kataloges ist für die EGLO Leuchten GmbH urheberrechtlich geschützt. Alle Rechte sind vorbehalten. Bilder und Texte dürfen nicht ohne vorherige ausdrückliche, schriftliche Genehmigung verwendet werden. Die Abbildungen sind 4C Drucke und können vom Original abweichen.

Die Katalogbilder und die gezeigten Darstellungen der Produkte können von der Wirklichkeit abweichen und nicht den üblichen Produktanwendungen entsprechen. EGLO übernimmt keine Haftung für die Richtigkeit, Vollständigkeit und Anwendungsdarstellung der Produkte und Produktinformationen.

Gestaltung, Layout und Satz:

EGLO GmbH, A-6136 Pill - AUSTRIA

Druck: Samson Druck GmbH, 5581 St. Margarethen - AUSTRIA

Bilder: EGLO, Adobe Stock, istockphoto.com, shutterstock.com

Le présent catalogue remplace tous les catalogues et tarifs précédents.

Sous réserve d'erreurs, de fautes d'impression, de modification des modèles et de changement de prix et de technique. Nous livrons sur la base de nos conditions de livraison et de paiement. Nos produits sont conformes aux normes européennes EN 60598 et portent le marquage CE. Les produits portant la marque ENEC sont conformes à la Directive 2006/95/EG. Les produits portant d'autres indications de sécurité (par exemple classe de protection, IP) sont identifiés par le symbole et le nombre correspondants dans la famille de produits.

Le contenu du présent catalogue est protégé pour la société EGLO Leuchten GmbH par un copyright. Tous droits réservés. Toute reproduction d'images et de texte est interdite sans autorisation explicite par écrit préalable. Les images sont imprimées en 4C et peuvent différer de l'original.

Les images des produits et les ambiances dans le catalogue peuvent dévier de la réalité et ne sont pas nécessairement en ligne avec l'usage habituel du produit. EGLO n'engage pas sa responsabilité sur la justesse des images et sur les informations relatives à l'usage pouvant être fait des produits.

Conception, maquette et composition :

EGLO GmbH, A-6136 Pill - AUSTRIA

Presso: Samson Druck GmbH, 5581 St. Margarethen - AUSTRIA

Images: EGLO, Adobe Stock, istockphoto.com, shutterstock.com

06-2022



# EGLO

Leuchten GmbH

Heiligkreuz 22  
AT - 6136 Pill

TEL: +43 (0) 5242 6996  
FAX: +43 (0) 5242 6996-972

[www.eglo.com](http://www.eglo.com)  
[info@eglo.com](mailto:info@eglo.com)



my light | my style